



Accessories

Accessories for industrial vacuum solutions



ООО "Скрабтек"

 <http://scrubtec.ru>

 info@scrubtec.ru

тел. +7 (495) 540-45-68

тел. +7(800) 707-66-48

 **Nilfisk®**

Accessories for industrial vacuums

Using the right accessory makes easier and efficient your daily work enhancing the performance of your Nilfisk industrial vacuum.

This catalogue allows you to identify the most suitable accessories for all vacuum cleaners and applications. In the tables, you will find the main features of the different accessories, an indication of the sectors where they are recommended to be used and if they are ATEX certified.

A short description of the food, pharma and ATEX range:

· Accessories for the food sector:

The color-coded program is one of the main requests of the food sector: each color is matched to a specific production area, in order to avoid any cross contamination or bacteria migration inside the plant. Nilfisk provides a selection of 6 colors of FDA approved accessories for any application. Moreover, a specific range for high temperatures is available, in order to meet any need in ovens cleaning and high temperature material collection, keeping the product quality at the top.

· Accessories for the pharmaceutical sector:

Nilfisk accessories for pharmaceutical applications are designed to meet any possible need in terms of safety, hygiene and efficiency. Accessories quality is at the top: FDA certified, the metal parts are made in stainless steel AISI 316L, they can be sterilized placing them in autoclave.

· Accessories for vacuum cleaners in ATEX zones

The range of ATEX accessories suitable for II 2D 2G has been developed in order to increase the safety of our industrial vacuums.



How to use the new and certified sequence of ATEX accessories

The ATEX sequence of accessories starts from the inlet which features a hole where to mount the first accessory with a pushbutton. The whole sequence of accessories can be then connected by using male and female parts, along the complete sequence, from the inlet to the final tool. Only accessories with these metal parts will be marked as certified. Here below the marking that all Nilfisk ATEX accessories will feature:

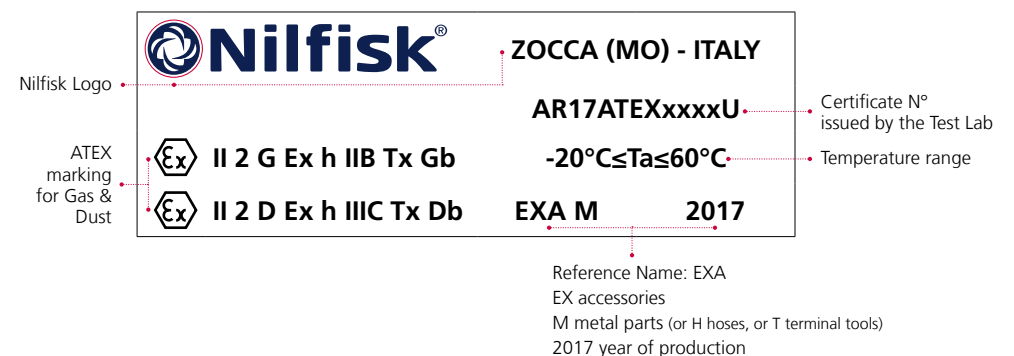

Please feel free to contact us at any time for more details or for the latest information.

+39 059 9730000 industrial-vacuum@nilfisk.com

Standard VS ATEX accessories

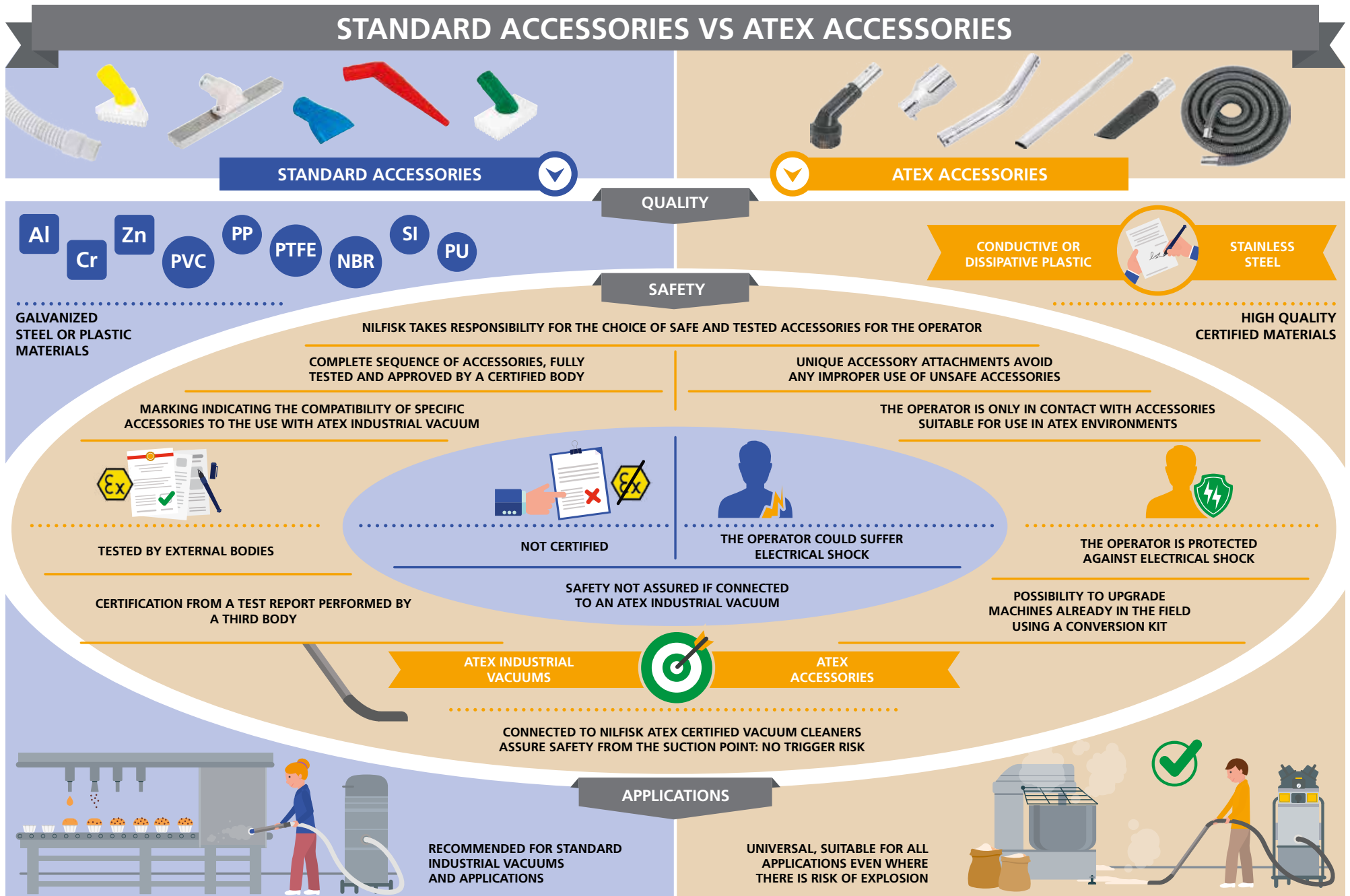

KEY TO ICONS:



METAL



**PHARMA/
CHEMICAL**



**HEAVY
INDUSTRY**



ATEX



FOOD



**BUILDING &
CONSTRUCTION**



**GENERAL
CLEANING**

Table of contents

ACCESSORIES FOR INDUSTRIAL VACUUMS	2	4 HANDGRIPS AND EXTENSIONS	
STANDARD VS ATEX ACCESSORIES	3	4.a Handgrips	42
		4.b Examples	45
1 CONNECTION DIAGRAMS		5 FLOOR NOZZLES AND BRUSHES	
1.a Nilfisk Vacuum cleaner	4	5.a Floor nozzles	48
1.b Nilfisk ATEX Vacuum cleaner	6	5.b Brushes	54
		5.c Examples	57
2 HOSES AND SLEEVES		6 FINAL TOOLS	
2.a Hoses	8	6.a Rubber tools	60
2.b Sleeves	24	6.b Examples	74
3 HOSE CONNECTORS AND REDUCTIONS		7 ACCESSORIES KIT	80
3.a Hose connectors	26		
3.b Reductions	31		
3.c Examples	38		

Connection Diagrams

1.a Nilfisk Vacuum Cleaner

How to connect **Nilfisk** accessories to **Nilfisk** vacuum cleaners.

- | | |
|---|---|
| A See chapter 3
Hose connectors and
Reductions | G See chapter 6.a
Crevice nozzles |
| B See chapter 2.b
Sleeves | H See chapter 5.b
Round brushes |
| C See chapter 2.a
Hoses | I See chapter 6
Final tools |
| D See chapter 4.a
Extensions | J See chapter 5.b
Brushes |
| E See chapter 3.a
Curved connectors | K See chapter 5.a
Nozzles |
| F See chapter 4.a
Handgrips | |

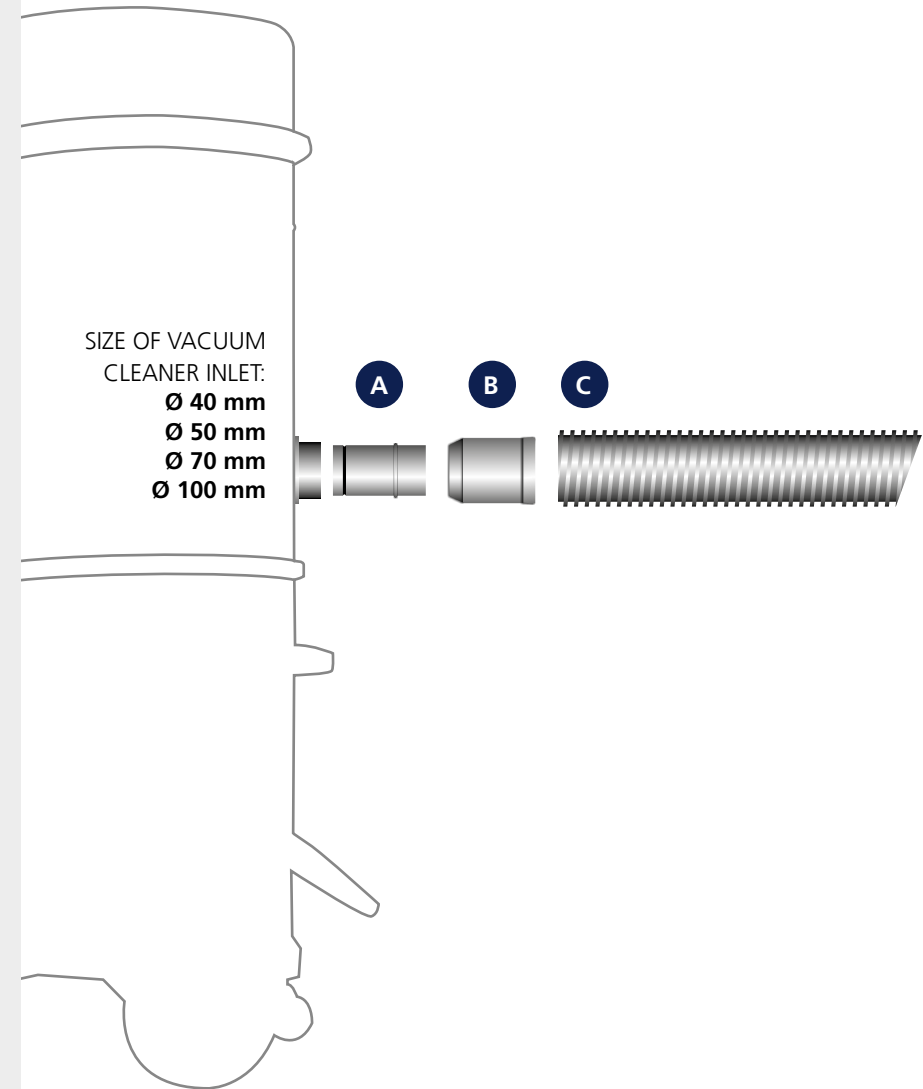

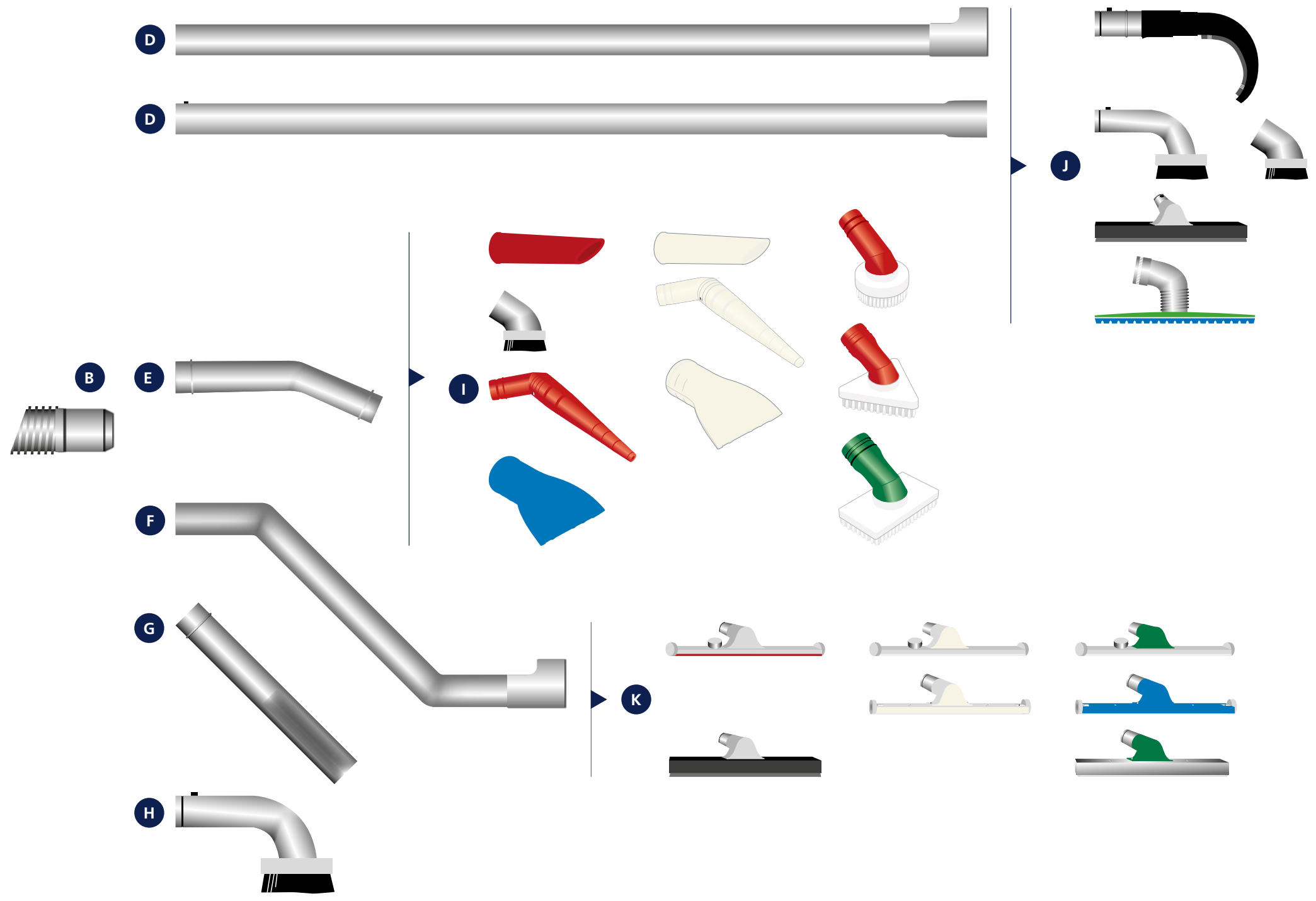

CONNECTION DIAGRAMS

1.b Nilfisk ATEX Vacuum Cleaner

How to connect accessories on an **ATEX** industrial vacuum.

- | | |
|---|---|
| A See chapter 7
Inlet | G See chapter 4.a
Handgrips |
| B See chapter 2.a
Hoses | H See chapter 6.a
Crevice nozzles |
| C See chapter 3.b
Reductions | I See chapter 5.b
Brushes |
| D See chapter 3.b
Bifurcations | J See chapter 6
Final tools |
| E See chapter 4.a
Extensions | K See chapter 5.a
Floor nozzles |
| F See chapter 3.a
Curved Connectors | |

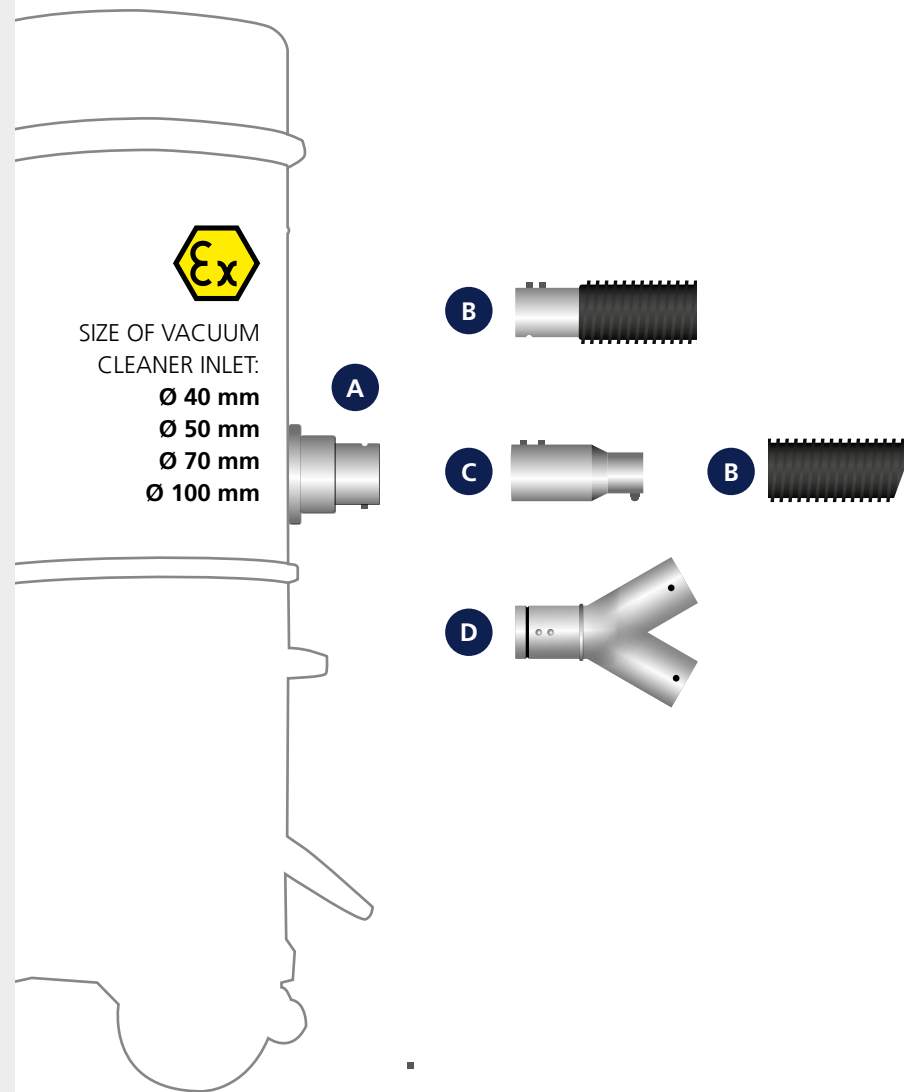

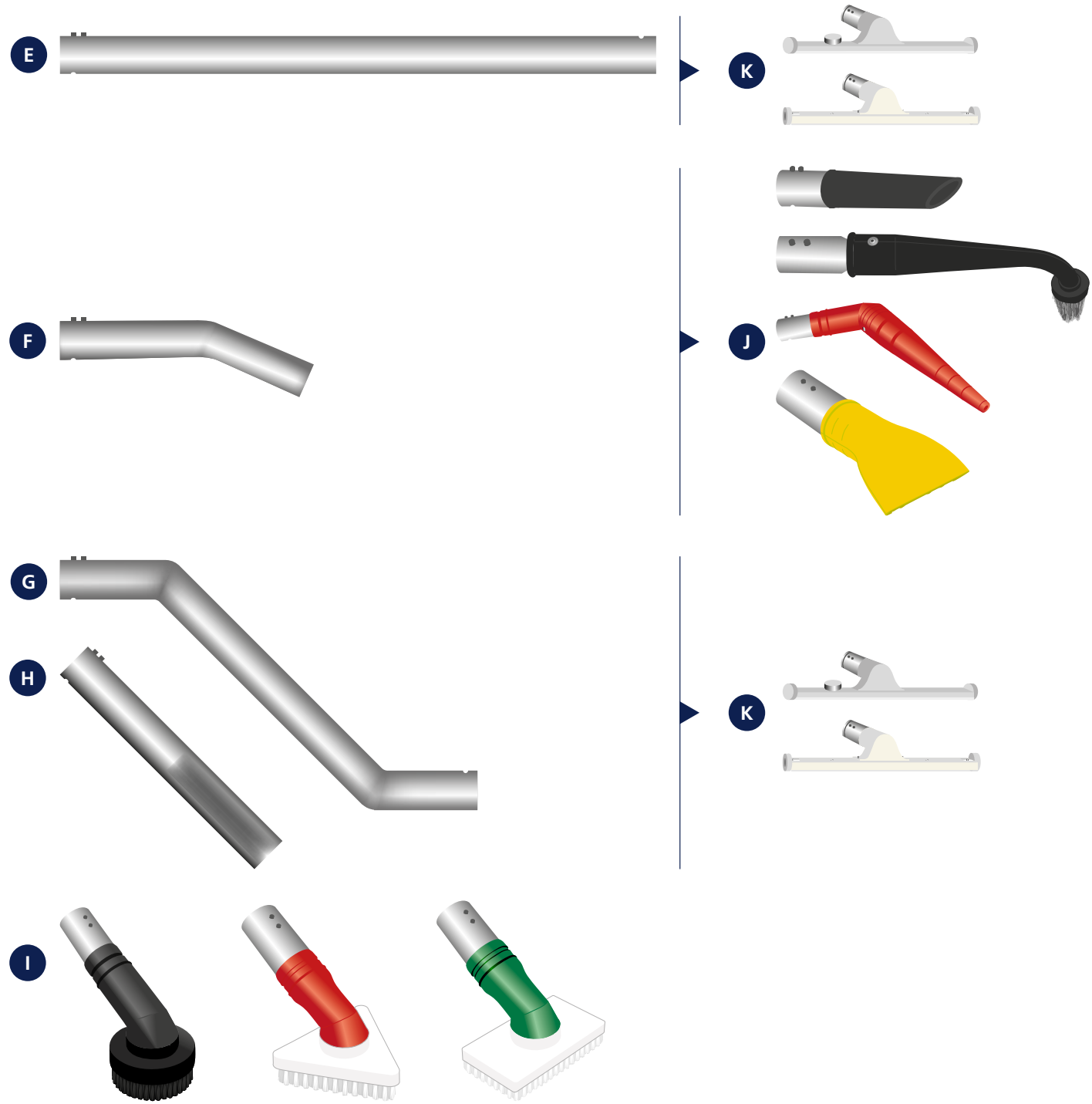









Hoses and Sleeves

This chapter contains tables with the descriptions of the various types of hoses, divided by application, and indications of the sleeves to choose based on the hose used.









The last part of the chapter contains useful examples of the connections between hoses and sleeves.

2.a Hoses

FLEX HOSE	Ø mm	LENGTH meters	MATERIAL	SLEEVES	FEATURES								SECTORS							CODE	
					OILPROOF	CONDUCTIVE (*)	ANTISTATIC (**)	HIGH TEMPERATURE	EXTREMELY FLEXIBLE	EXTREMELY LIGHT	AUTOCLAVABLE	CERTIFIED THIRD PARTY APPROVAL									
	40	3	In EVA (ethyl-vinyl-acetate) spiralled and unreinforced + PVC sleeves	included (Z7 23022)					•	•								•	Z7 22150		
		5																	•	Z7 22360	
		15								•	•								•	4072200469	
		30		not included (P/N to order: Z7 23022)						•	•								•	4072400231	
	50	3		included (Z7 23023)						•	•									•	Z7 22151
		5																		•	Z7 22361
		15								•	•									•	4072200470
		30 complete roll		not included (P/N to order: Z7 23023)						•	•									•	4072400232
The Flex Hose is suitable for cleaning dust and non-abrasive materials. It is a light and flexible grey hose, corrugated both externally and on the inside. Range of temperature: -30° C +60° C.																					

(*) **Conductive** A conductive hose is a hose with a volume resistance < 10⁴ ohm. It may have a conductor built in. (**) **Antistatic** An antistatic hose is a hose with a volume resistance < 10⁹ ohm and/or with a conductor built in.

2.a Hoses

AIR HOSE	Ø mm	LENGTH meters	MATERIAL	SLEEVES	FEATURES								SECTORS							CODE	
					OILPROOF	CONDUCTIVE (*)	ANTISTATIC (**)	HIGH TEMPERATURE	EXTREMELY FLEXIBLE	EXTREMELY LIGHT	AUTOCLAVABLE	CERTIFIED THIRD PARTY APPROVAL									
	30	by meter	Plastified PVC hose with rigid PVC spiral + rubber sleeves	N/A					•	•				•	•	•			•	Z8 24023	
	40	3		included (Z7 20001)						•	•				•	•	•			•	Z7 22049
		5								•	•				•	•	•			•	Z7 22362
		10								•	•				•	•	•			•	4072200504
		15								•	•				•	•	•			•	4072200471
		50 complete roll				not included (P/N to order: Z7 20001)					•	•				•	•	•			•
	50	3		included (Z7 20002)						•	•				•	•	•			•	Z7 22062
		5								•	•				•	•	•			•	Z7 22363
		10								•	•				•	•	•			•	4072200505
		15								•	•				•	•	•			•	4072200472
		50 complete roll				not included (P/N to order: Z7 20002)					•	•				•	•	•			•
	70	3		included (Z7 20003)						•	•				•	•	•			•	Z7 22063
		5								•	•				•	•	•			•	Z7 22364
		10								•	•				•	•	•			•	4072200506
		15								•	•				•	•	•			•	4072200473
		50 complete roll				not included (P/N to order: Z7 20003)					•	•				•	•	•			•
	100	by meter		not included (P/N to order 4072000362)						•	•				•	•	•			•	Z7 24027
		30 complete roll								•	•				•	•	•			•	4072400230

The Air Hose is ideal for cleaning dust and non-abrasive materials. It is a light, flexible, grey hose. It is corrugated externally and smooth on the inside. Range of temperature: -10° C +60° C.

(*) **Conductive** A conductive hose is a hose with a volume resistance < 10⁴ ohm. It may have a conductor built in. (**) **Antistatic** An antistatic hose is a hose with a volume resistance < 10⁹ ohm and/or with a conductor built in.

2.a Hoses

FLEX CONDUCTIVE HOSE	Ø mm	LENGTH meters	MATERIAL	SLEEVES	FEATURES								SECTORS							CODE	
					OILPROOF	CONDUCTIVE (*)	ANTISTATIC (**)	HIGH TEMPERATURE	EXTREMELY FLEXIBLE	EXTREMELY LIGHT	AUTOCLAVABLE	CERTIFIED THIRD PARTY APPROVAL									
	38/40	3	Spiral conductive PE hose with reinforcement on the external spiral with antiabrasion function + conductive polyurethane sleeves	4072000343		•			•	•						•		•	•	4072200509	
		5		4072000343		•			•	•							•		•	•	4072200510
		15		4072000343		•			•	•							•		•	•	4072200480
		30 complete roll		not included (P/N to be ordered 4072000343)		•			•	•							•		•	•	4072400233
	50	3		Z7 20325		•			•	•							•		•	•	Z7 22375
		5		Z7 20325		•			•	•							•		•	•	Z7 22377
		15		Z7 20325		•			•	•							•		•	•	4072200481
		30 complete roll		not included (P/N to be ordered Z7 20325)		•			•	•							•		•	•	4072400234
	70	3		4072000348		•			•	•							•		•	•	4072200542
		5		4072000348		•			•	•							•		•	•	4072200543

The Flex hose is a conductive hose made of polyethylene and ethyl-vinyl-acetate (EVA). It is suitable for cleaning dust, non-abrasive materials, and conductive materials. It is black, with a grey line on the ridge; it is flexible and is corrugated externally and smooth on the inside. Range of temperature: -20° / + 60°C

(*) **Conductive** A conductive hose is a hose with a volume resistance < 10⁴ ohm. It may have a conductor built in. (**) **Antistatic** An antistatic hose is a hose with a volume resistance < 10⁹ ohm and/or with a conductor built in.

2.a Hoses

CONDUCTIVE POLYURETHANE HOSE	Ø mm	LENGTH meters	MATERIAL	SLEEVES	FEATURES								SECTORS						CODE				
					OILPROOF	CONDUCTIVE (*)	ANTISTATIC (**)	HIGH TEMPERATURE	EXTREMELY FLEXIBLE	EXTREMELY LIGHT	AUTOCLAVABLE	CERTIFIED THIRD PARTY APPROVAL											
	40	3	PU conductive flexible, spiral tube with copper-plated steel armor covered in conductive PU + conductive polyurethane sleeves	40000212	•	•								•			•	•		•	Z7 22368		
		5		40000212	•	•									•			•	•		•	Z7 22371	
		10		40000212	•	•									•			•	•		•	Z7 22351	
		15		40000212	•	•									•			•	•		•	4072200477	
	50	3		40000219	•	•									•			•	•		•	Z7 22369	
		5		40000219	•	•									•			•	•		•	Z7 22372	
		10		40000219	•	•									•			•	•		•	Z7 22352	
		15		40000219	•	•									•			•	•		•	4072200478	
	70	3		Z7 20310	•	•									•			•	•		•	Z7 22370	
		5		Z7 20310	•	•									•			•	•		•	Z7 22373	
		15		Z7 20310	•	•									•			•	•		•	4072200479	
	100	by meter		not included (P/N to order Z8 40044 - metal tie)	•	•									•			•	•		•	4072400259	
	<p>The conductive polyurethane hose can be used for cleaning abrasive materials, conductive materials, and liquids. It is black, highly flexible and is corrugated externally and smooth on the inside. Range of temperature: -30° / + 90°C.</p>																						

(*) **Conductive** A conductive hose is a hose with a volume resistance < 10⁴ ohm. It may have a conductor built in. (**) **Antistatic** An antistatic hose is a hose with a volume resistance < 10⁹ ohm and/or with a conductor built in.

2.a Hoses

CONDUCTIVE POLYURETHANE EXA HOSE	Ø mm	LENGTH meters	MATERIAL	SLEEVES	FEATURES								SECTORS							CODE				
					OILPROOF	CONDUCTIVE (*)	ANTISTATIC (**)	HIGH TEMPERATURE	EXTREMELY FLEXIBLE	EXTREMELY LIGHT	AUTOCLAVABLE	CERTIFIED THIRD PARTY APPROVAL												
	40	3	Conductive polyurethane hose + Stainless Steel AISI 304 hose connectors	Male and female connectors + heat shrink sleeve	•	•							•	•			•	•			4072400489			
		5			•	•							•	•			•	•					4072400490	
		10			•	•										•	•			•	•			4072400491
		15			•	•										•	•			•	•			4072400492
	50	3			•	•										•	•			•	•			4072400493
		5			•	•										•	•			•	•			4072400494
		10			•	•										•	•			•	•			4072400495
		15			•	•										•	•			•	•			4072400496
	70	3			•	•										•	•			•	•			4072400497
		5			•	•										•	•			•	•			4072400498
		10			•	•										•	•			•	•			4072400499
		15			•	•										•	•			•	•			4072400500
	100	3			•	•										•	•			•	•			4072400501
		5			•	•										•	•			•	•			4072400502
		10			•	•										•	•			•	•			4072400503
		15			•	•										•	•			•	•			4072400504

The conductive polyurethane hose can be used for cleaning abrasive materials, conductive materials, and liquids. It is black, highly flexible and is corrugated externally and smooth on the inside. It is connected with two metal connectors through a rivet and covered by a black heat shrink cover. Metal connectors will be marked according to the type of hose. Range of temperature: -30° / + 90°C.

(*) **Conductive** A conductive hose is a hose with a volume resistance < 10⁴ ohm. It may have a conductor built in. (**) **Antistatic** An antistatic hose is a hose with a volume resistance < 10⁹ ohm and/or with a conductor built in.

2.a Hoses

RUBBER HOSE	Ø mm	LENGTH meters	MATERIAL	SLEEVES	FEATURES								SECTORS							CODE	
					OILPROOF	CONDUCTIVE (*)	ANTISTATIC (**)	HIGH TEMPERATURE	EXTREMELY FLEXIBLE	EXTREMELY LIGHT	AUTOCLAVABLE	CERTIFIED THIRD PARTY APPROVAL									
	40	3	Smooth black conductive rubber, abrasion resistant	Integrated sleeves	•	•		•					•			•	•	•	Z7 24005		
		5			•	•		•					•			•	•	•	Z7 24178		
	50	3			•	•		•							•			•	•	•	Z7 24003
		5			•	•		•							•			•	•	•	Z7 24179
	70	3			•	•		•							•			•	•	•	Z7 24001
		5			•	•		•							•			•	•	•	Z7 24180
	50	5			•	•		•							•			•	•	•	ZA7240005
		10			•	•		•							•			•	•	•	ZA7240003
	70	5			•	•		•							•			•	•	•	ZA7240015
		10			•	•		•							•			•	•	•	ZA7240018
	100	5			•	•		•							•			•	•	•	ZA7240011
		10			•	•		•							•			•	•	•	ZA7240042

The rubber oilproof hose is suitable for cleaning metal shavings mixed with traces of oil, dust and conductive materials. It is corrugated externally and smooth on the inside. It has a metal wire to earth the hose. Temperature range - 40° / + 120°C.

RUBBER EXA HOSE	Ø mm	LENGTH meters	MATERIAL	SLEEVES	FEATURES								SECTORS							CODE	
					OILPROOF	CONDUCTIVE (*)	ANTISTATIC (**)	HIGH TEMPERATURE	EXTREMELY FLEXIBLE	EXTREMELY LIGHT	AUTOCLAVABLE	CERTIFIED THIRD PARTY APPROVAL									
	40	3	Conductive rubber hose + Stainless Steel AISI 304 hose connectors	Male and female connectors + heat shrink sleeve	•	•		•					•	•		•	•	•	4072400483		
		5			•	•		•						•	•		•	•	•	4072400484	
	50	3			•	•		•							•	•		•	•	•	4072400485
		5			•	•		•							•	•		•	•	•	4072400486
	70	3			•	•		•							•	•		•	•	•	4072400487
		5			•	•		•							•	•		•	•	•	4072400488

The rubber oilproof hose is suitable for cleaning metal shavings mixed with traces of oil, dust and conductive materials. It is corrugated externally and smooth on the inside. It has a metal wire to earth the hose. It is connected with two metal connectors through a rivet and covered by a black heat shrink cover. Metal connectors will be marked according to the type of hose. Temperature range - 40° / + 120°C.

(*) **Conductive** A conductive hose is a hose with a volume resistance < 10⁴ ohm. It may have a conductor built in. (**) **Antistatic** An antistatic hose is a hose with a volume resistance < 10⁹ ohm and/or with a conductor built in.









2.a Hoses

FLEX CONDUCTIVE EXA HOSE	Ø mm	LENGTH meters	MATERIAL	SLEEVES	FEATURES								SECTORS							CODE
					OILPROOF	CONDUCTIVE (*)	ANTISTATIC (**)	HIGH TEMPERATURE	EXTREMELY FLEXIBLE	EXTREMELY LIGHT	AUTOCLAVABLE	CERTIFIED THIRD PARTY APPROVAL								
	40	3	Abrasion-resistant polyurethane with internal PVC-coated spring steel spiral	Male and female connectors + heat shrink sleeve		•			•	•		•	•		•	•	•	4072400451		
		5				•			•	•		•	•		•	•	•	4072400452		
		10				•			•	•		•	•		•	•	•	4072400453		
		15				•			•	•		•	•		•	•	•	4072400454		
	50	3						•			•	•		•	•		•	•	•	4072400455
		5						•			•	•		•	•		•	•	•	4072400456
		10						•			•	•		•	•		•	•	•	4072400457
		15						•			•	•		•	•		•	•	•	4072400458
	70	3						•			•	•		•	•		•	•	•	4072400667
		5						•			•	•		•	•		•	•	•	4072400657
		10						•			•	•		•	•		•	•	•	4072400668
		15						•			•	•		•	•		•	•	•	4072400669
	100	3						•			•	•		•	•		•	•	•	4072400670
		5						•			•	•		•	•		•	•	•	4072400671
		10						•			•	•		•	•		•	•	•	4072400672
		15						•			•	•		•	•		•	•	•	4072400673

The new Flex conductive hose is a conductive hose made of abrasion resistant polyurethane. It is highly suitable in potentially explosive atmospheres for conveying abrasive solids such as dusts and powders. It is black, very flexible and light. It is corrugated externally and smooth on the inside. It will resist from -40 °C to +90 °C. It is connected with two metal connectors through a rivet and covered by a black heat shrink cover. Metal connectors will be marked according to the type of hose.

(*) **Conductive** A conductive hose is a hose with a volume resistance < 10⁴ ohm. It may have a conductor built in. (**) **Antistatic** An antistatic hose is a hose with a volume resistance < 10⁹ ohm and/or with a conductor built in.

2.a Hoses

POLYURETHANE HOSE	Ø mm	LENGTH meters	MATERIAL	SLEEVES	FEATURES								SECTORS							CODE			
					OILPROOF	CONDUCTIVE (*)	ANTISTATIC (**)	HIGH TEMPERATURE	EXTREMELY FLEXIBLE	EXTREMELY LIGHT	AUTOCLAVABLE	CERTIFIED THIRD PARTY APPROVAL											
	40	3	Polyurethane hose with steel spiral + polyurethane sleeves	40000212			•							•			•	•		•	Z7 22297		
		5		40000212			•								•			•	•		•	Z7 22365	
		15		40000212			•									•			•	•		•	4072200474
	50	3		40000219			•									•			•	•		•	Z7 22298
		5		40000219			•									•			•	•		•	Z7 22366
		15		40000219			•									•			•	•		•	4072200475
	70	3		Z7 20310			•									•			•	•		•	Z7 22299
		5		Z7 20310			•									•			•	•		•	Z7 22367
		15		Z7 20310			•									•			•	•		•	4072200476
	100	sold by meter, max 15m		not included (P/N to order Z8 40044 - metal tie)			•								•			•	•		•	Z7 24113	
	<p>The polyurethane hose is suitable for cleaning abrasive materials and liquids. It is transparent with a grey spiral. It is corrugated externally and smooth on the inside. It also has a steel spiral to be connected properly. The hose must be installed so the small arrow on the outside is pointing towards the inlet of the vacuum cleaner. Range of temperature: - 40° / + 90°C.</p>																						

(*) **Conductive** A conductive hose is a hose with a volume resistance < 10⁴ ohm. It may have a conductor built in. (**) **Antistatic** An antistatic hose is a hose with a volume resistance < 10⁹ ohm and/or with a conductor built in.

2.a Hoses

FLEX ANTISTATIC EXA HOSE	Ø mm	LENGTH meters	MATERIAL	SLEEVES	FEATURES								SECTORS							CODE	
					OILPROOF	CONDUCTIVE (*)	ANTISTATIC (**)	HIGH TEMPERATURE	EXTREMELY FLEXIBLE	EXTREMELY LIGHT	AUTOCLAVABLE	CERTIFIED THIRD PARTY APPROVAL									
	40	3	PVC with coated spring steel spiral + Stainless Steel AISI 304 hose connectors	Male and female connectors + heat shrink sleeve			•		•	•			•	•			•	•	•	• for EXA machines	4072400459
		5					•		•	•			•	•			•	•	•		4072400460
		10					•		•	•			•	•			•	•	•		4072400461
		15					•		•	•			•	•			•	•	•		4072400462
	50	3					•		•	•			•	•			•	•	•		4072400463
		5					•		•	•			•	•			•	•	•		4072400464
		10					•		•	•			•	•			•	•	•		4072400465
		15					•		•	•			•	•			•	•	•		4072400466
	70	3					•		•	•			•	•			•	•	•		4072400674
		5					•		•	•			•	•			•	•	•		4072400675
		10					•		•	•			•	•			•	•	•		4072400676
		15					•		•	•			•	•			•	•	•		4072400677
	100	3					•		•	•			•	•			•	•	•		4072400678
		5					•		•	•			•	•			•	•	•		4072400679
		10					•		•	•			•	•			•	•	•		4072400680
		15					•		•	•			•	•			•	•	•		4072400681

The new flex antistatic hose is made with PVC with a coated steel spiral that is properly grounded and connected to metal hose connectors to guarantee the continuity. It is suitable for cleaning abrasive materials and liquids. It is very flexible and light. It is slightly corrugated externally but with a PVC cover and smooth on the inside. Range of temperature: from 0 °C to +85 °C It is connected with two metal connectors through a rivet and covered by a black heat shrink cover. Metal connectors will be marked according to the type of hose.

ANTISTATIC NON TOXIC HOSE	Ø mm	LENGTH meters	MATERIAL	SLEEVES	FEATURES								SECTORS							CODE
					OILPROOF	CONDUCTIVE (*)	ANTISTATIC (**)	HIGH TEMPERATURE	EXTREMELY FLEXIBLE	EXTREMELY LIGHT	AUTOCLAVABLE	CERTIFIED THIRD PARTY APPROVAL								
	30	sold by meter	PVC hose with rigid PVC spiral and underlay in transparent polyurethane and copper wire	not included (P/N to order Z8 40040 or Z8 40044 - metal ties)			•									•	•		• Z7 24054	
	40						•										•	•		• Z7 24028
	50						•										•	•		• Z7 24029
	70						•										•	•		• Z7 24030
	100						•										•	•		• Z7 24069

The non-toxic anti-static hose is suitable for cleaning abrasive and granular materials, it is corrugated on the outside and smooth inside. It is suitable for contact with food products as it is FDA approved. It also has a metal spiral to be connected properly. Range of temperature: from - 10 °C to +60 °C.

(*) **Conductive** A conductive hose is a hose with a volume resistance < 10⁴ ohm. It may have a conductor built in. (**) **Antistatic** An antistatic hose is a hose with a volume resistance < 10⁹ ohm and/or with a conductor built in.

CONNECTION DIAGRAMS
 HOSES AND SLEEVES
 HOSE CONNECTORS AND REDUCTIONS
 HANDGRIPS AND EXTENSIONS
 FLOOR NOZZLES AND BRUSHES
 TERMINALI
 ACCESSORIES KIT

2.a Hoses

SILICONE HOSE	Ø mm	LENGTH meters	MATERIAL	SLEEVES	FEATURES								SECTORS							CODE		
					OILPROOF	CONDUCTIVE (*)	ANTISTATIC (**)	HIGH TEMPERATURE	EXTREMELY FLEXIBLE	EXTREMELY LIGHT	AUTOCLAVABLE	CERTIFIED THIRD PARTY APPROVAL										
	40	sold by meter	White silicone hose with Stainless Steel wire	not included				•				•				•	•				•	Z7 24189
	50							•					•				•	•				
<p>The silicone hose is designed for cleaning powder from foodstuffs and pharmaceutical mixtures (FDA approved). It is white, resistant to high temperatures (up to 200 °C) and therefore can be sterilized in autoclave (at 121 °C). It has a stainless steel spiral to earth the hose; it is smooth on the inside and slightly smooth externally. Range of temperature: - 60 °C to +200 °C.</p>																						

SILICONE EXA HOSE	Ø mm	LENGTH meters	MATERIAL	SLEEVES	FEATURES								SECTORS							CODE					
					OILPROOF	CONDUCTIVE (*)	ANTISTATIC (**)	HIGH TEMPERATURE	EXTREMELY FLEXIBLE	EXTREMELY LIGHT	AUTOCLAVABLE	CERTIFIED THIRD PARTY APPROVAL													
	40	3M	White silicone hose with Stainless Steel wire + Stainless Steel AISI 304 hose connectors	Male and female connectors + heat shrink sleeve			•	•				•	•			•	•				• for EXA machines	4072400475			
		5M					•	•			•	•			•	•							4072400476		
		10M					•	•			•	•			•	•								4072400477	
		15M					•	•			•	•			•	•								4072400478	
	50	3M							•	•				•	•			•	•						4072400479
		5M							•	•				•	•			•	•						4072400480
		10M							•	•				•	•			•	•						4072400481
		15M							•	•				•	•			•	•						4072400482
<p>The silicone hose is designed for cleaning powder from foodstuffs and pharmaceutical mixtures (FDA approved). It is white, resistant to high temperatures (up to 200 °C) and therefore can be sterilized in autoclave (at 121 °C). It has a stainless steel spiral to earth the hose; it is smooth on the inside and slightly smooth externally. It is connected with two metal connectors through a rivet and covered with a white heat shrink cover. Metal connectors will be marked according to the type of hose. Range of temperature: - 60 °C to +200 °C.</p>																									

SMOOTH SILICONE HOSE	Ø mm	LENGTH meters	MATERIAL	SLEEVES	FEATURES								SECTORS							CODE				
					OILPROOF	CONDUCTIVE (*)	ANTISTATIC (**)	HIGH TEMPERATURE	EXTREMELY FLEXIBLE	EXTREMELY LIGHT	AUTOCLAVABLE	CERTIFIED THIRD PARTY APPROVAL												
	40	3	White silicone hose with Stainless Steel wire	Integrated sleeves				•				•				•	•				•	4072100135		
		5						•				•			•	•						•	4072100137	
	50	3								•				•				•	•				•	4072100136
		5								•				•				•	•				•	4072100138
<p>The silicone hose is designed for cleaning powder from foodstuffs and pharmaceutical mixtures (FDA approved). It is white, resistant to high temperatures (up to 200 °C) and therefore can be sterilized in autoclave (at 121 °C). It has a stainless steel spiral to earth the hose; it is smooth both on the inside and externally. Range of temperature: - 60 °C to +200 °C.</p>																								

(*) **Conductive** A conductive hose is a hose with a volume resistance < 10⁴ ohm. It may have a conductor built in. (**) **Antistatic** An antistatic hose is a hose with a volume resistance < 10⁹ ohm and/or with a conductor built in.

2.a Hoses

TRANSPARENT FDA HOSE	Ø mm	LENGTH meters	MATERIAL	SLEEVES	FEATURES								SECTORS							CODE			
					OILPROOF	CONDUCTIVE (*)	ANTISTATIC (**)	HIGH TEMPERATURE	EXTREMELY FLEXIBLE	EXTREMELY LIGHT	AUTOCLAVABLE	CERTIFIED THIRD PARTY APPROVAL											
	40	3	Transparent polyurethane FDA hose with steel wire + FDA approved white sleeves	4072000358						•					•	•				•	4072400334		
		5		4072000358							•					•	•				•	4072400336	
		10		4072000358							•					•	•				•	4072400338	
		15		4072000358							•					•	•				•	4072400414	
	50	3		4072000359								•					•	•				•	4072400335
		5		4072000359								•					•	•				•	4072400337
		10		4072000359								•					•	•				•	4072400339
		15		4072000359								•					•	•				•	4072400415
<p>The transparent antistatic hose is the most suitable for the Food & Pharma sectors. It is made with FDA approved material, it is compliant with European Regulations 1935/2004/CE. It is very flexible and light. It is transparent in order to guarantee a better visual check. In case of usage in ATEX environment, the hose has to be connected properly. Temperature range: -40°C / +90°C.</p>																							

TRANSPARENT ANTISTATIC FDA HOSE	Ø mm	LENGTH meters	MATERIAL	SLEEVES	FEATURES								SECTORS							CODE				
					OILPROOF	CONDUCTIVE (*)	ANTISTATIC (**)	HIGH TEMPERATURE	EXTREMELY FLEXIBLE	EXTREMELY LIGHT	AUTOCLAVABLE	CERTIFIED THIRD PARTY APPROVAL												
	40	3	Transparent polyurethane FDA hose with steel wire + FDA approved white sleeves + assembled grounding plates	4072000358			•				•					•	•				•	4072400438		
		5		4072000358								•					•	•				•	4072400440	
		10		4072000358									•					•	•				•	4072400442
		15		4072000358									•					•	•				•	4072400444
	50	3		4072000359									•					•	•				•	4072400439
		5		4072000359									•					•	•				•	4072400441
		10		4072000359									•					•	•				•	4072400443
		15		4072000359									•					•	•				•	4072400445
<p>The transparent antistatic hose is the most suitable for the Food & Pharma sectors. It is made with FDA approved material, it is compliant with European Regulations 1935/2004/CE. It is very flexible and light. It is transparent in order to guarantee a better visual check. The ground continuity can be guaranteed only by connecting the steel spiral properly so with already assembled grounding plates. Temperature range: -40°C / +90°C.</p>																								

(*) **Conductive** A conductive hose is a hose with a volume resistance < 10⁴ ohm. It may have a conductor built in. (**) **Antistatic** An antistatic hose is a hose with a volume resistance < 10⁹ ohm and/or with a conductor built in.

2.a Hoses

TRANSPARENT ANTISTATIC FDA EXA HOSE	Ø mm	LENGTH meters	MATERIAL	SLEEVES	FEATURES								SECTORS							CODE			
					OILPROOF	CONDUCTIVE (*)	ANTISTATIC (**)	HIGH TEMPERATURE	EXTREMELY FLEXIBLE	EXTREMELY LIGHT	AUTOCLAVABLE	CERTIFIED THIRD PARTY APPROVAL											
	40	3M	Transparent antistatic polyurethane with steel wire + Stainless Steel AISI 304 hose connectors	Male and female connectors + heat shrink sleeve			•		•	•		•		•	•					4072400467			
		5M					•		•	•		•	•									4072400468	
		10M					•		•	•		•	•										4072400469
		15M					•		•	•		•	•										4072400470
	50	3M							•		•	•		•		•	•						4072400471
		5M							•		•	•		•		•	•						4072400472
		10M							•		•	•		•		•	•						4072400473
		15M							•		•	•		•		•	•						4072400474
	70	3M							•		•	•		•		•	•						4072400643
		5M							•		•	•		•		•	•						4072400644
		10M							•		•	•		•		•	•						4072400645
		15M							•		•	•		•		•	•						4072400646
	100	3M							•		•	•		•		•	•						4072400647
		5M							•		•	•		•		•	•						4072400648
		10M							•		•	•		•		•	•						4072400649
		15M							•		•	•		•		•	•						4072400650

The transparent antistatic hose is the most suitable for the Food & Pharma sectors. It is made with FDA approved material, it is compliant with European Regulations 1935/2004/CE. It is very flexible and light. It is transparent in order to guarantee a better visual check. It is connected with two metal connectors through a rivet and covered with a white heat shrink cover. Metal connectors will be marked according to the type of hose. Temperature range: -40°C / +90°C.

FDA RUBBER HOSE	Ø mm	LENGTH meters	MATERIAL	SLEEVES	FEATURES								SECTORS							CODE	
					OILPROOF	CONDUCTIVE (*)	ANTISTATIC (**)	HIGH TEMPERATURE	EXTREMELY FLEXIBLE	EXTREMELY LIGHT	AUTOCLAVABLE	CERTIFIED THIRD PARTY APPROVAL									
	40	3	White FDA NBR with blue cover	Integrated sleeves	•																4072400202
	50	3			•																

Light and flexible hose suitable for food applications.

(*) **Conductive** A conductive hose is a hose with a volume resistance < 10⁴ ohm. It may have a conductor built in. (**) **Antistatic** An antistatic hose is a hose with a volume resistance < 10⁹ ohm and/or with a conductor built in.

2.a Hoses

STEEL HOSE	Ø mm	LENGTH meters	MATERIAL	SLEEVES	FEATURES								SECTORS							CODE		
					OILPROOF	CONDUCTIVE (*)	ANTISTATIC (**)	HIGH TEMPERATURE	EXTREMELY FLEXIBLE	EXTREMELY LIGHT	AUTOCLAVABLE	CERTIFIED THIRD PARTY APPROVAL										
	40	3	Flexible galvanized steel hose	D50/40 reduction and 40I/40E hose connector included				•						•	•		•	•	•	Z7 22378		
	50	3		D50/40 reduction and 40I/40E hose connector included				•							•	•		•	•	•	Z7 22379	
	40	1		not included (P/N to order Z8 40040 for D40 and D50, Z8 4044 for D70 and D100 - metal ties)					•							•	•		•	•	•	4072400417
		3							•							•	•		•	•	•	4072400421
		5							•							•	•		•	•	•	4072400425
		10							•							•	•		•	•	•	4072400429
		15						•							•	•		•	•	•	4072400433	
	50	1							•						•	•		•	•	•	4072400418	
		3							•						•	•		•	•	•	4072400422	
		5							•						•	•		•	•	•	4072400426	
		10							•						•	•		•	•	•	4072400430	
		15							•						•	•		•	•	•	4072400434	
	70	1							•						•	•		•	•	•	4072400419	
		3							•						•	•		•	•	•	4072400423	
		5							•						•	•		•	•	•	4072400427	
		10							•						•	•		•	•	•	4072400431	
		15							•						•	•		•	•	•	4072400435	
	100	1						•						•	•		•	•	•	4072400420		
		3						•						•	•		•	•	•	4072400424		
		5						•						•	•		•	•	•	4072400428		
10							•						•	•		•	•	•	4072400432			
15							•						•	•		•	•	•	4072400436			

The steel hose is recommended for cleaning incandescent and highly-abrasive materials. It is corrugated both externally and on the inside. The 3 m version with metal reductions included should be used with extensions that have the harmonic spring coupling (see chapter 4.b). For hoses by meter, metal reductions are not included. The hose can resist up to 500°C.

(*) **Conductive** A conductive hose is a hose with a volume resistance < 10⁴ ohm. It may have a conductor built in. (**) **Antistatic** An antistatic hose is a hose with a volume resistance < 10⁹ ohm and/or with a conductor built in.

2.a Hoses

FLEXIBLE HIGH TEMPERATURE HOSE	Ø mm	LENGTH meters	MATERIAL	SLEEVES	FEATURES								SECTORS						CODE	
					OILPROOF	CONDUCTIVE (*)	ANTISTATIC (**)	HIGH TEMPERATURE	EXTREMELY FLEXIBLE	EXTREMELY LIGHT	AUTOCLAVABLE	CERTIFIED THIRD PARTY APPROVAL								
	40	by meter	Silicone reinforced tissue for high temperatures with galvanized steel spiral	not included (P/N to order 4082300068 for D40, 4082300071 for D50 - metal ties)				•	•	•				•	•		•	•	•	4072400330
	50	by meter								•	•	•				•	•		•	•









The high temperature hose meets any need in ovens cleaning and high temperature material collection. It is corrugated inside and outside, and very flexible and light. It can resist up to 400°C.

HOSES FOR IVT1000	Ø mm	LENGTH meters	MATERIAL	SLEEVES	FEATURES								SECTORS						CODE		
					OILPROOF	CONDUCTIVE (*)	ANTISTATIC (**)	HIGH TEMPERATURE	EXTREMELY FLEXIBLE	EXTREMELY LIGHT	AUTOCLAVABLE	CERTIFIED THIRD PARTY APPROVAL									
	32	3	Plastic hose with plastic sleeves	L01716100					•	•							•	•		80553100	
			Conductive hose with conductive sleeves							•	•							•	•		80552900
			Silicone hose with Stainless Steel ties	Integrated sleeves															•	•	

These hoses are designed specifically for the IVT1000: The **grey plastic hose** is very flexible and light. It is corrugated externally and smooth on the inside. The **black conductive hose** is very flexible and light. It is conductive, corrugated externally and on the inside. These 2 hoses are suitable for cleaning dust and non-abrasive materials. The **white silicone hose** is highly flexible, lightweight and smooth both on the inside and externally. It is ideal for cleaning pharmaceutical powders and mixtures (FDA approved), as it can also be sterilized in an autoclave (at 121° C).

(*) **Conductive** A conductive hose is a hose with a volume resistance < 10⁴ ohm. It may have a conductor built in. (**) **Antistatic** An antistatic hose is a hose with a volume resistance < 10⁹ ohm and/or with a conductor built in.

2.a Hoses









CONNECTION EXA HOSES	Ø mm	LENGTH meters	MATERIAL	SLEEVES	FEATURES								SECTORS								CODE			
					OILPROOF	CONDUCTIVE (*)	ANTISTATIC (**)	HIGH TEMPERATURE	EXTREMELY FLEXIBLE	EXTREMELY LIGHT	AUTOCLAVABLE	CERTIFIED THIRD PARTY APPROVAL												
	40	5	Abrasion-resistant polyurethane with internal PVC-coated spring steel spiral + Stainless Steel AISI 304 hose connector	Male connector + heat shrink sleeve		•				•	•			•	•			•	•	•	4072400640			
		3	Transparent antistatic polyurethane with steel wire + Stainless Steel AISI 304 hose connector								•	•			•	•			•	•	•	4072400624		
		5										•	•			•	•			•	•	•	4072400625	
		10											•	•			•	•			•	•	•	4072400626
		15											•	•			•	•			•	•	•	4072400627
	50	3											•	•			•	•			•	•	•	4072400628
		5											•	•			•	•			•	•	•	4072400629
		10											•	•			•	•			•	•	•	4072400630
		15											•	•			•	•			•	•	•	4072400631
	70	3											•	•			•	•			•	•	•	4072400632
		5											•	•			•	•			•	•	•	4072400633
		10											•	•			•	•			•	•	•	4072400634
		15											•	•			•	•			•	•	•	4072400635
	100	3											•	•			•	•			•	•	•	4072400636
		5											•	•			•	•			•	•	•	4072400637
		10											•	•			•	•			•	•	•	4072400638
		15										•	•			•	•			•	•	•	4072400639	
	40	3			Conductive polyurethane hose + Stainless Steel AISI 304 hose connector		•	•							•	•				•	•	•	4072400616	
		5						•	•						•	•				•	•	•	4072400617	
		10						•	•						•	•				•	•	•	4072400618	
15						•	•						•	•				•	•	•	4072400619			

• for EXA machines

(*) **Conductive** A conductive hose is a hose with a volume resistance < 10⁴ ohm. It may have a conductor built in. (**) **Antistatic** An antistatic hose is a hose with a volume resistance < 10⁹ ohm and/or with a conductor built in.

CONNECTION DIAGRAMS
 HOSES AND SLEEVES
 HOSE CONNECTORS AND REDUCTIONS
 HANDGRIPS AND EXTENSIONS
 FLOOR NOZZLES AND BRUSHES
 TERMINALI
 ACCESSORIES KIT









2.a Hoses









CONNECTION EXA HOSES	Ø mm	LENGTH meters	MATERIAL	SLEEVES	FEATURES								SECTORS							CODE		
					OILPROOF	CONDUCTIVE (*)	ANTISTATIC (**)	HIGH TEMPERATURE	EXTREMELY FLEXIBLE	EXTREMELY LIGHT	AUTOCLAVABLE	CERTIFIED THIRD PARTY APPROVAL										
	50	3	Conductive polyurethane hose + Stainless Steel AISI 304 hose connector	Male connector + heat shrink sleeve	•	•						•	•			•	•	•	• for EXA machines	4072400620		
		5			•	•					•	•			•	•	•	4072400621				
		10			•	•					•	•			•	•	•	4072400622				
		15			•	•					•	•			•	•	•	4072400623				
	70	3				•	•							•	•			•		•	•	4072400604
		5				•	•							•	•			•		•	•	4072400610
		10				•	•							•	•			•		•	•	4072400611
	100	10				•	•							•	•			•		•	•	4072400660
		15		•	•							•	•			•	•	•		4072400666		
	50	5	Smooth black conductive rubber, abrasion resistant		•	•		•				•	•			•	•	•				









The connection hoses are made up of 1 male connection and the hose. It has an open bottom. It can be used to connect the hose with an EXA machine and on the other side you can connect the overhead cleaning kit (see page 90), the processing machines of the customer, or separators.

(*) **Conductive** A conductive hose is a hose with a volume resistance < 10⁴ ohm. It may have a conductor built in. (**) **Antistatic** An antistatic hose is a hose with a volume resistance < 10⁹ ohm and/or with a conductor built in.

2.b Sleeves

PVC SLEEVES	Ø mm	MATERIAL	FEATURES			SECTORS							COLOUR	CODE
			CONDUCTIVE (*)	AUTOCLAVABLE	CERTIFIED THIRD PARTY APPROVAL									
	40	PVC											■ GREY	Z7 23022
	50													Z7 23023
The rigid, grey PVC sleeve connects to the Flex hose.														

RUBBER SLEEVES	Ø mm	MATERIAL	FEATURES			SECTORS							COLOUR	CODE
			CONDUCTIVE (*)	AUTOCLAVABLE	CERTIFIED THIRD PARTY APPROVAL									
	40	RUBBER											■ BLACK	Z7 20001
	50													Z7 20002
	70													Z7 20003
The black rubber sleeve connects to the Air hose.														

POLYURETHANE SLEEVES	Ø mm	MATERIAL	FEATURES			SECTORS							COLOUR	CODE
			CONDUCTIVE (*)	AUTOCLAVABLE	CERTIFIED THIRD PARTY APPROVAL									
	40	CONDUCTIVE POLYURETHANE	•										■ BLACK	40000212
	50		•											40000219
	70		•											Z7 20310
The black polyurethane sleeve is conductive. This sleeve is designed specifically for the polyurethane hose and the conductive polyurethane hose.														

(*) **Conductive** A conductive sleeve is a sleeve with a volume resistance < 10⁴ ohm.

2.a Sleeves

POLYURETHANE SLEEVES	Ø mm	MATERIAL	FEATURES			SECTORS							COLOUR	CODE
			CONDUCTIVE (*)	AUTOCLAVABLE	CERTIFIED THIRD PARTY APPROVAL									
	38/40	CONDUCTIVE POLYURETHANE	•									■ BLACK	4072000343	
	50		•										Z7 20325	
	70		•											4072000348
The black polyurethane sleeve is conductive. This sleeve connects to the Flex conductive hose.														

FDA COLOURED POLYURETHANE SLEEVES	Ø mm	MATERIAL	FEATURES			SECTORS							COLOUR	CODE	
			CONDUCTIVE (*)	AUTOCLAVABLE	CERTIFIED THIRD PARTY APPROVAL										
	40	FDA POLYURETHANE		•									■ WHITE	4072000358	
				•									■ BLUE	4072000363	
				•										■ YELLOW	4072000364
				•										■ RED	4072000365
				•										■ GREEN	4072000366
	50			•										■ WHITE	4072000359
				•										■ BLUE	4072000367
				•										■ YELLOW	4072000368
				•										■ RED	4072000369
				•										■ GREEN	4072000370
The white FDA polyurethane sleeve is designed for the antistatic FDA transparent hose. Coloured versions are available.															

(*) **Conductive** A conductive sleeve is a sleeve with a volume resistance < 10⁴ ohm.

Hose connectors and Reductions

Thanks to the range of hose connectors, reductions, bifurcations and trifurcations, the users can find the most appropriate combinations to meet their needs.

You can fit several sections of hose together quickly, to reach various parts of the environment at the same time, or connect Nilfisk hoses to old Nilfisk vacuum cleaners.

Some of the most common example connections can be found at the end of the chapter.



















3.a Hose connectors









HOSE FITTING	Ø mm	MATERIAL	FEATURES		SECTORS							COLOR	NOTES	CODE	
			AUTOCLAVABLE	CERTIFIED THIRD PARTY APPROVAL	☑	☑	☑	☑	☑	☑	☑				☑
	40	ZINC-PLATED			•				•	•	•		1 internal flange and 1 external flange	Z7 21005	
		STAINLESS STEEL AISI 304	•		•				•	•	•	•		Z7 22229	
	50	ZINC-PLATED			•				•	•	•			Z7 21003	
		STAINLESS STEEL AISI 304	•		•				•	•	•	•		Z7 22230	
		STAINLESS STEEL AISI 316L	•			•	•			•	•			4072100139	
		STAINLESS STEEL AISI 316L + COLOURED SILICONE RING	•				•	•			•	•		■ BLUE	4072400343
			•				•	•			•	•		■ RED	4072400344
			•				•	•			•	•		■ YELLOW	4072400345
			•				•	•			•	•		■ WHITE	4072400346
			•				•	•			•	•		■ GREEN	4072400347
	70	ZINC-PLATED			•				•	•	•			Z7 21001	
		STAINLESS STEEL AISI 304	•		•				•	•	•	•		Z7 22231	
		ZINC-PLATED			•				•	•	•			Z7 21040	
		STAINLESS STEEL AISI 304	•		•				•	•	•	•		Z7 22232	

The hose fitting is an element that lets you connect a hose to any Nilfisk vacuum cleaner that has a quick-fit inlet. Coloured versions have an internal flange with a coloured silicone ring.

3.a Hose connectors

JOINT/ REDUCER FOR WALL INLET EXA	Ø mm	MATERIAL	FEATURES		SECTORS							COLOR	NOTES	CODE
			AUTOCLAVABLE	CERTIFIED THIRD PARTY APPROVAL										
	50	STAINLESS STEEL AISI 304	•	•	•	•	•	•	•	•	for EXA machines		Hole for the EXA connection	4578300103
	70		•	•	•	•	•	•	•	•		4578300102		
	50/40		•	•	•	•	•	•	•	•		4578300100		
	70/50		•	•	•	•	•	•	•	•		4578300101		
	100/70		•	•	•	•	•	•	•	•		4578300104		
These joints and reducers have been developed to connect all EXA certified accessories to the wall inlet of fixed pipings.														

HOSE FITTING WITH FLOW REGULATOR	Ø mm	MATERIAL	FEATURES		SECTORS							COLOR	NOTES	CODE
			AUTOCLAVABLE	CERTIFIED THIRD PARTY APPROVAL										
	50	ZINC-PLATED			•				•				1 internal flange and 1 external flange	Z7 22058
		STAINLESS STEEL AISI 304	•		•				•	•				Z7 22221
	70	ZINC-PLATED			•				•					Z7 22113
		STAINLESS STEEL AISI 304	•		•				•	•				Z7 22222
	100	ZINC-PLATED			•				•					Z7 22144
		STAINLESS STEEL AISI 304	•		•				•	•	•			Z7 22206
The hose fitting with flow regulator is a special hose connector which, as well as connecting the hose to a Nilfisk vacuum cleaner, lets you regulate the vacuum power by hand.														

ADAPTER	Ø mm	MATERIAL	FEATURES		SECTORS							COLOR	NOTES	CODE
			AUTOCLAVABLE	CERTIFIED THIRD PARTY APPROVAL										
	38/40	ZINC-PLATED AND CHROMED COMPONENTS			•				•	•	•		To be used to connect an old Nilfisk machine having the bayonet connection inlet to a Nilfisk IVS hose	Z7 22380
	50/40		•						•	•	•			Z7 22381
	50/50		•						•	•	•			Z7 22382
	38/40	ZINC-PLATED			•				•	•	•		1 external flange and a ball to connect to bayonet coupling, code 22329900	Z7 22355
	50/40		•					•	•	•		1 external flange and a ball to connect to bayonet coupling, code 22344200	Z7 22356	
	50/50		•						•	•	•		Z7 22357	
	38	CHROMED			•				•	•	•		Only for old Nilfisk machines having the bayonet connection inlet	22329900
	50		•					•	•	•		22344200		
The bayonet coupling adaptor is used to connect an old Nilfisk vacuum cleaner with a Nilfisk hose. An adapter for the Nilfisk bayonet fitting and bayonets only is also available. The bayo adapter is suitable for old Nilfisk machines having the bayonet connection inlet.														









3.a Hose connectors

JUNCTION FITTING	Ø mm	MATERIAL	FEATURES		SECTORS							COLOR	NOTES	CODE
			AUTOCLAVABLE	CERTIFIED THIRD PARTY APPROVAL										
	40	ZINC-PLATED			•			•	•	•			Z7 21004	
		STAINLESS STEEL AISI 304	•		•			•	•	•	•		Z7 22240	
		STAINLESS STEEL AISI 316L	•			•	•					•	4072100140	
		STAINLESS STEEL AISI 316L + COLOURED SILICONE RING	•			•	•					•	■ BLUE	4072400348
			•			•	•					•	■ RED	4072400349
			•			•	•					•	■ YELLOW	4072400350
			•			•	•					•	■ WHITE	4072400351
			•			•	•					•	■ GREEN	4072400352
	50	ZINC-PLATED			•			•	•	•			Z7 21002	
		STAINLESS STEEL AISI 304	•		•			•	•	•	•		Z7 22241	
		STAINLESS STEEL AISI 316L	•			•	•				•		4072100141	
		STAINLESS STEEL AISI 316L + COLOURED SILICONE RING	•			•	•					•	■ BLUE	4072400353
			•			•	•					•	■ RED	4072400354
			•			•	•					•	■ YELLOW	4072400355
			•			•	•					•	■ WHITE	4072400356
	•			•	•					•	■ GREEN	4072400357		
	70	ZINC-PLATED			•			•	•	•			Z7 21000	
		STAINLESS STEEL AISI 304	•		•			•	•	•	•		Z7 22242	
	100	ZINC-PLATED			•			•	•	•			Z7 21041	
	<p>The junction fitting is a component used to connect two hoses or a hose and a rubber or plastic accessory/tool. The diameters of the components are the same. Coloured versions have an internal flange with a coloured silicone ring.</p>													

2 external flanges

CONNECTION DIAGRAMS
 HOSES AND SLEEVES
 HOSE CONNECTORS AND REDUCTIONS
 HANDGRIPS AND EXTENSIONS
 FLOOR NOZZLES AND BRUSHES
 TERMINAL
 ACCESSORIES KIT

3.a Hose connectors

BENT FITTING	Ø mm	MATERIAL	FEATURES		SECTORS							COLOR	NOTES	CODE		
			AUTOCLAVABLE	CERTIFIED THIRD PARTY APPROVAL												
	40	ZINC-PLATED			•				•	•	•		2 external flanges	Z7 21013		
		STAINLESS STEEL AISI 304	•		•				•	•	•	•			Z7 21033	
		STAINLESS STEEL AISI 316L	•			•	•					•			4072100145	
		STAINLESS STEEL AISI 316L + COLOURED SILICONE RING	•			•	•					•		■ BLUE		4072400373
			•			•	•					•		■ RED		4072400374
			•			•	•					•		■ YELLOW		4072400375
			•			•	•					•		■ WHITE		4072400376
		•			•	•					•	■ GREEN			4072400377	
	STAINLESS STEEL AISI 304	•	•	•				•	•	•	•	• for EXA machines	EXA connection	4072100160		
	50	ZINC-PLATED			•				•	•	•		2 external flanges	Z7 21012		
		STAINLESS STEEL AISI 304	•		•				•	•	•			Z7 21034		
		STAINLESS STEEL AISI 316L	•			•	•				•			4072100146		
		STAINLESS STEEL AISI 316L + COLOURED SILICONE RING	•			•	•					•		■ BLUE		4072400378
			•			•	•					•		■ RED		4072400379
•					•	•					•	■ YELLOW			4072400380	
•					•	•					•	■ WHITE			4072400381	
•				•	•					•	■ GREEN			4072400382		
STAINLESS STEEL AISI 304	•	•	•				•	•	•	•	• for EXA machines	EXA connection	4072100161			
70	ZINC-PLATED			•				•	•	•		2 external flanges	Z7 21032			
	STAINLESS STEEL AISI 304	•		•				•	•	•	•		4072100099			

The curved fitting is a component used to fit a hose to a rubber or plastic accessory/tool. It is often used when you have to clean places that are hard to reach.
The curved fitting with reduction is a special version of this component. Coloured versions have an internal flange with a coloured silicone ring.









3.a Hose connectors

BENT FITTING WITH REDUCTION	Ø mm	MATERIAL	FEATURES		SECTORS							COLOR	NOTES	CODE
			AUTOCLAVABLE	CERTIFIED THIRD PARTY APPROVAL										
	40/38	ZINC-PLATED			•				•	•	•		1 external flange	Z7 22358
		STAINLESS STEEL AISI 304	•		•				•	•	•	•		Z7 22359
	70/50	ZINC-PLATED			•				•	•	•			Z7 22015
						•				•	•	•		Z7 22153
<p>The curved fitting is a component used to fit a hose to a rubber or plastic accessory/tool. It is often used when you have to clean places that are hard to reach. The curved fitting with reduction is a special version of this component. Coloured versions have an internal flange with a coloured silicone ring.</p>														

QUICK-FIT FITTING	Ø mm	MATERIAL	FEATURES		SECTORS							COLOR	NOTES	CODE
			AUTOCLAVABLE	CERTIFIED THIRD PARTY APPROVAL										
	40	ZINC-PLATED			•					•	•		1 quick-fit fitting, 1 external flange	Z7 22186
	50				•					•	•			Z7 22187
	70				•					•	•			Z7 22188
<p>The quick-fit fitting is a simple and quick connector to use between two hoses or a hose and a rubber tool. The quick-fit fitting is always used with a hose connector or, if necessary, a reduction. The diameters of the components may be different.</p>														

EXTENSION FITTING WITH PIN	Ø mm	MATERIAL	FEATURES		SECTORS							COLOR	NOTES	CODE
			AUTOCLAVABLE	CERTIFIED THIRD PARTY APPROVAL										
	40/38	ZINC-PLATED			•					•	•		1 internal flange, 1 quick-fit coupling with harmonic spring, 1 external flange. To use as a connecting element between quick-fit extensions with harmonic springs and coloured floor nozzles and brushes (50 mm diameter)	4072200389
	50/40				•					•	•		1 quick-fit coupling with harmonic spring. To use as a connecting element between quick-fit extensions with harmonic springs and round brushes (38mm diameter)	4072200387
	50				•					•	•		1 internal flange, 1 quick-fit coupling with harmonic spring, 1 external flange. To use as a connecting element between quick-fit extensions with harmonic springs and coloured floor nozzles and brushes (50 mm diameter)	4072200388
	40/38				•					•	•		Lets you fit the old Nilfisk tools	4072200390
<p>The extension fitting is a special fitting used to connect quick-fit extensions with harmonic springs to specific final accessories/tools. In particular, the extension fitting with reduction (code 4072200390), assembled on the 40mm diameter curved fitting , lets you fit 38 mm diameter old Nilfisk tools.</p>														

3.b Reduction







REDUCTION	Ø mm	MATERIAL	FEATURES		SECTORS							COLOR	NOTES	CODE		
			AUTOCLAVABLE	CERTIFIED THIRD PARTY APPROVAL												
 	40/32	STAINLESS STEEL AISI 304	•		•			•	•	•	•		1 internal flange, 1 external flange	Z7 22347		
	50/32	ZINC-PLATED			•			•	•	•				Z7 22313		
	50/32	STAINLESS STEEL AISI 304	•		•			•	•	•	•			Z7 22346		
	50/40	ZINC-PLATED				•			•	•	•				Z7 22000	
		STAINLESS STEEL AISI 304	•		•			•	•	•	•				Z7 22223	
		STAINLESS STEEL AISI 316L	•			•	•				•				4072100142	
		STAINLESS STEEL AISI 316L + COLOURED SILICONE RING	•				•	•				•		■ BLUE		4072400358
			•				•	•				•		■ RED		4072400359
			•				•	•				•		■ YELLOW		4072400360
	•					•	•				•	■ WHITE			4072400361	
	•				•	•				•	■ GREEN		4072400362			
	STAINLESS STEEL AISI 304	•	•	•				•	•	•	•	for EXA machines	EXA connection	4072100153		
	70/40	ZINC-PLATED				•								1 internal flange, 1 external flange	Z7 22002	
		STAINLESS STEEL AISI 304	•		•						•				Z7 22224	
		STAINLESS STEEL AISI 316L	•			•	•				•				4072100143	
		STAINLESS STEEL AISI 316L + COLOURED SILICONE RING	•				•	•				•	■ BLUE			4072400363
			•				•	•				•	■ RED			4072400364
			•				•	•				•	■ YELLOW			4072400365
			•				•	•				•	■ WHITE			4072400366
		•				•	•				•	■ GREEN		4072400367		
STAINLESS STEEL AISI 304	•	•	•				•	•	•	•	for EXA machines	EXA connection	4072100154			

3.b Reduction

REDUCTION	Ø mm	MATERIAL	FEATURES		SECTORS							COLOR	NOTES	CODE	
			AUTOCLAVABLE	CERTIFIED THIRD PARTY APPROVAL											
	70/50	ZINC-PLATED			•			•	•	•					Z7 22001
		STAINLESS STEEL AISI 304	•		•			•	•	•	•				Z7 22225
		STAINLESS STEEL AISI 316L	•			•	•					•			4072100144
	70/50	STAINLESS STEEL AISI 316L + COLOURED SILICONE RING	•			•	•					•	■ BLUE	1 internal flange, 1 external flange	4072400368
			•			•	•					•	■ RED		4072400369
			•			•	•					•	■ YELLOW		4072400370
			•			•	•					•	■ WHITE		4072400371
			•			•	•					•	■ GREEN		4072400372
		STAINLESS STEEL AISI 304	•	•	•			•	•	•	•			EXA connection	4072100155
	100/50	ZINC-PLATED				•			•	•	•			1 internal flange, 1 external flange	Z7 22126
		STAINLESS STEEL AISI 304	•			•			•	•	•				Z7 22226
			•	•	•				•	•	•	•			EXA connection
100/70	ZINC-PLATED				•			•	•	•			1 internal flange, 1 external flange	Z7 22125	
	STAINLESS STEEL AISI 304	•			•			•	•	•				Z7 22227	
		•	•	•				•	•	•	•			EXA connection	4072100157

The reduction is a fitting that goes between a vacuum cleaner with a quick-fit inlet and a hose that has a smaller diameter than the inlet. The diameters of the components are different.

3.b Reduction









REDUCTION WITH FLOW REGULATOR	Ø mm	MATERIAL	FEATURES		SECTORS						COLOR	NOTES	CODE
			AUTOCLAVABLE	CERTIFIED THIRD PARTY APPROVAL									
	50/40	ZINC-PLATED			•			•	•	•		1 internal flange, 1 external flange	Z7 22112
		STAINLESS STEEL AISI 304	•		•			•	•	•	•		Z7 22234
	70/40	ZINC-PLATED			•			•	•	•		1 internal flange, 1 external flange	Z7 22164
		STAINLESS STEEL AISI 304	•		•			•	•	•	•		Z7 22235
	70/50	ZINC-PLATED			•			•	•	•		1 internal flange, 1 external flange	Z7 22162
		STAINLESS STEEL AISI 304	•		•			•	•	•	•		Z7 22236
				•	•	•			•	•	•	•	•
	100/50	ZINC-PLATED			•			•	•	•			Z7 22165
	100/70				•			•	•	•		Z7 22163	
	The reduction with flow regulator is a special reduction which, as well as connecting the vacuum cleaner to a hose (with a smaller diameter than the inlet), lets you regulate the vacuum power by hand.												









3.b Reduction

BIFURCATION	Ø mm	MATERIAL	FEATURES		SECTORS							COLOR	NOTES	CODE
			AUTOCLAVABLE	CERTIFIED THIRD PARTY APPROVAL										
	40/40/40	ZINC-PLATED			•			•	•	•				Z7 22061
		STAINLESS STEEL AISI 304	•		•			•	•	•	•			
	50/50/50	ZINC-PLATED			•			•	•	•			1 internal flange	Z7 22059
		STAINLESS STEEL AISI 304	•		•			•	•	•	•			Z7 22146
		STAINLESS STEEL AISI 316L	•			•	•				•			4072100147
		STAINLESS STEEL AISI 316L + COLOURED SILICONE RING	•			•	•				•	BLUE		
	•				•	•				•	RED		4072400384	
	•				•	•				•	YELLOW		4072400385	
	•				•	•				•	WHITE		4072400386	
			•		•	•				•	GREEN		4072400387	
	STAINLESS STEEL AISI 304	•	•	•			•	•	•	•	for EXA machines	EXA connection	4072100158	
70/70/70	ZINC-PLATED			•			•	•	•			1 internal flange	Z7 22110	
	•			•			•	•	•	•			Z7 22282	
	STAINLESS STEEL AISI 304	•	•	•			•	•	•	•	•	for EXA machines	EXA connection	4072100159
	ZINC-PLATED			•			•	•	•			1 internal flange	Z7 22135	
100/100/100	STAINLESS STEEL AISI 304	•		•			•	•	•	•			Z7 22157	

The bifurcation is a fitting used to connect the vacuum cleaner to two different hoses or, between hoses in general. Coloured versions have an internal flange with a coloured silicone ring.

3.b Reduction

BIFURCATION WITH REDUCTION	Ø mm	MATERIAL	FEATURES		SECTORS								COLOR	NOTES	CODE
			AUTOCLAVABLE	CERTIFIED THIRD PARTY APPROVAL											
	40/32/32	ZINC-PLATED			•				•	•	•		1 internal flange	Z7 22253	
	50/32/32				•				•	•	•			Z7 22254	
	50/40/40				•				•	•	•			Z7 22060	
	50/40/40	STAINLESS STEEL AISI 304	•		•			•	•	•	•			Z7 22261	
	70/32/32	ZINC-PLATED			•				•	•	•			Z7 22252	
	70/40/40				•			•	•	•		Z7 22111			
	70/40/40	STAINLESS STEEL AISI 304	•		•			•	•	•	•			Z7 22262	
	70/50/50	ZINC-PLATED			•				•	•	•			Z7 22064	
		STAINLESS STEEL AISI 304	•		•			•	•	•	•			Z7 22263	
	100/50/50	ZINC-PLATED			•				•	•	•			Z7 22128	
100/70/70					•			•	•	•		Z7 22127			
		STAINLESS STEEL AISI 304	•		•			•	•	•	•		Z7 22307		
<p>The bifurcation with reduction is a special bifurcation which, as well as letting you clean in two different places, connects the vacuum cleaner to two hoses of a smaller diameter than the inlet on the machine. Alternatively you can connect a hose to two others with smaller diameters than the first.</p>															

BIFURCATION WITH FLOW REGULATOR	Ø mm	MATERIAL	FEATURES		SECTORS								COLOR	NOTES	CODE
			AUTOCLAVABLE	CERTIFIED THIRD PARTY APPROVAL											
	40/40/40	ZINC-PLATED			•				•	•	•		1 internal flange	Z7 22114	
	50/50/50					•			•	•	•			Z7 22056	
			STAINLESS STEEL AISI 304	•		•			•	•	•	•			Z7 22250
<p>The bifurcation with flow regulator is a special bifurcation which, a well as letting you clean in two different places, also lets you regulate the vacuum power of both tools.</p>															

3.b Reduction

BIFURCATION WITH REDUCTION AND FLOW REGULATOR	Ø mm	MATERIAL	FEATURES		SECTORS								COLOR	NOTES	CODE
			AUTOCLAVABLE	CERTIFIED THIRD PARTY APPROVAL											
	50/40/40	ZINC-PLATED			•				•	•	•			1 internal flange	Z7 22057
	70/50/50	ZINC-PLATED			•				•	•	•				Z7 22065
		STAINLESS STEEL AISI 304	•		•				•	•	•	•			Z7 22249
	100/50/50	ZINC-PLATED			•				•	•	•				Z7 22130
	100/70/70				•				•	•	•				Z7 22129
The bifurcation with reduction and flow regulator is a bifurcation with reduction for cleaning in two different places, and the vacuum power can be regulated manually for each tool.															

TRIFURCATION	Ø mm	MATERIAL	FEATURES		SECTORS								COLOR	NOTES	CODE
			AUTOCLAVABLE	CERTIFIED THIRD PARTY APPROVAL											
	50/50/50/50	ZINC-PLATED			•				•	•	•			1 internal flange	ZS07RW22027
The trifurcation is a fitting used to connect the vacuum cleaner to three different hoses or, between hoses in general. The trifurcation lets you clean in three different places using the same vacuum cleaner.															

TRIFURCATION WITH FLOW REGULATOR	Ø mm	MATERIAL	FEATURES		SECTORS								COLOR	NOTES	CODE
			AUTOCLAVABLE	CERTIFIED THIRD PARTY APPROVAL											
	50/50/50/50	ZINC-PLATED			•				•	•	•			1 internal flange	Z7 22179
The trifurcation with flow regulator is a special trifurcation which, a well as letting you clean in three different places, also lets you regulate the vacuum power of all three tools.															

3.b Reduction

TRIFURCATION WITH REDUCTION	Ø mm	MATERIAL	FEATURES		SECTORS							COLOR	NOTES	CODE
			AUTOCLAVABLE	CERTIFIED THIRD PARTY APPROVAL										
	50/40/40/40	ZINC-PLATED			•			•	•	•			1 internal flange	Z7 22260
	70/50/50/50				•			•	•	•				Z7 22259
	100/50/50/50				•			•	•	•				ZS07IS22105
<p>The trifurcation with reduction is a special trifurcation which, as well as letting you clean in three different places, connects the vacuum cleaner to three hoses of a smaller diameter than the inlet on the machine. It can also be used to connect a hose to three other hoses of a smaller diameter.</p>														

3.c Examples: hose connectors and reductions



Ø 40 mm
Nilfisk
inlet

A



Ø 40 mm
Hose fitting
Z7 21005

C

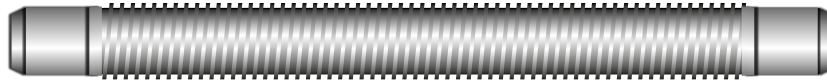

Ø 40 mm
3-meter Rubber Hose with sleeves
Z7 24005



Ø 70 mm
Nilfisk
inlet

A



Ø 70/50 mm
Reduction
Z7 22001

C

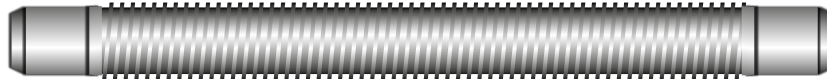

Ø 50 mm
3-meter conductive Flex Hose with sleeves
Z7 24053

A

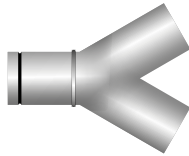

Ø 70/70/70 mm
Bifurcation
Z7 22110

C

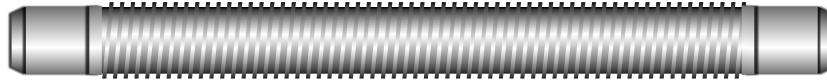

Ø 70 mm
3-meter Polyurethane Hose with sleeves
Z7 22367

C

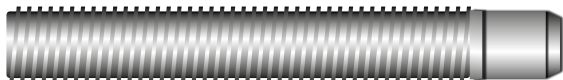

Ø 40 mm
3-meter Flex Hose with sleeves
Z7 22150

E

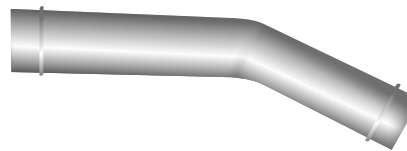

Ø 40 mm
Curved fitting
Z7 21013

3.c Examples: hose connectors and reductions

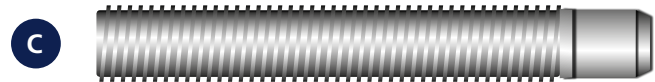

Ø 50 mm
3-meter Air Hose with sleeves
Z7 22062

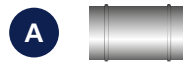

Ø 50 mm
Junction Fitting
Z7 21002

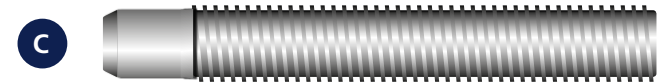

Ø 50 mm
3-meter Air Hose with sleeves
Z7 22062

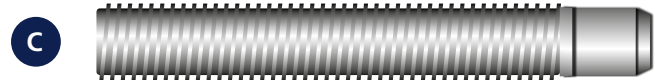

Ø 50 mm
3-meter Air Hose with sleeves
Z7 22062



Ø 50 mm
Hose fitting
Z7 21003



Ø 50 mm
Quick-fit fitting
Z7 22187

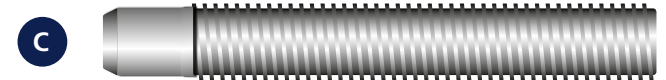

Ø 50 mm
3-meter Air Hose with sleeves
Z7 22062



Ø 50 mm
Old Nilfisk
inlet
Ø 38 mm
Old Nilfisk
inlet
Ø 50 mm
Old Nilfisk
inlet



Ø 50/40 mm
Complete bayonet coupling
adaptor **Z7 22381**
Ø 38/40 mm
Complete bayonet coupling
adaptor **Z7 22380**
Ø 50/50 mm
Complete bayonet coupling
adaptor **Z7 22382**



Ø 40 mm
3-meter conductive Polyurethane Hose with sleeves
Z7 22368
Ø 38 mm
3-meter conductive Flex Hose with sleeves
Z7 22374
Ø 50 mm
3-meter Rubber Hose with sleeves
Z7 24003

3.c Examples: hose connectors and reductions

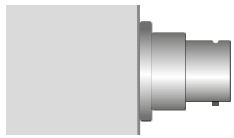

Ø 70 mm
EXA Machine
inlet

C



Ø 70/40 mm
Reduction
4072100154

B

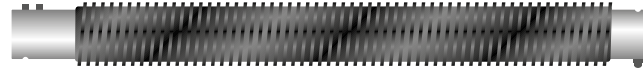

Ø 40 mm
3-meter Flex Antistatic Hose
4072400459

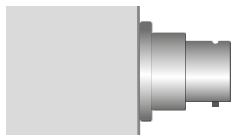

Ø 70 mm
EXA Machine
inlet

D

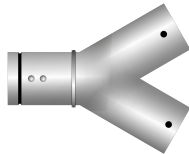

Ø 70/70/70 mm
Reduction
4072100159

B



Ø 70 mm
5-meter Transparent Antistatic Hose
4072400644

C



Ø 70/50 mm
Reduction
4072100155

B



Ø 50 mm
3-meter Flex Conductive Hose
4072400455

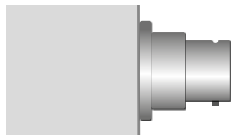

Ø 40 mm
EXA Machine
inlet

B



Ø 40 mm
3-meter flex conductive hose
4072400451

F



Ø 40 mm
Bent Fitting
4072100160

3.c Examples: hose connectors and reductions

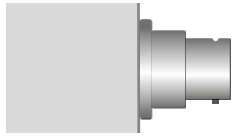

Ø 50 mm
EXA Machine
inlet

B



Ø 50 mm
3-meter Flex Conductive Hose
4072400455

B

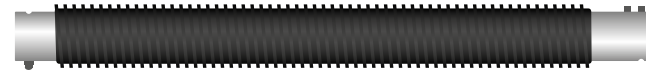

Ø 50 mm
3-meter Flex Conductive Hose
4072400455

Handgrips and Extensions

The handgrips are essential for cleaning floors and should be used with the floor nozzle.

Fitted with a quick-fit coupling, the handgrips can be fitted to the floor nozzle quickly and simply.

The extensions are tubular elements for cleaning walls and other overhead areas in general.

Different kinds of extensions are available: dedicated extensions for cleaning ovens (with sliding PTFE sleeve) and those for cleaning pipes in raised areas.

In the last section you will find some of the possible connection schemes between handgrips and floor nozzles, and between extensions and different final tools/accessories.



4.a Handgrips

HANDGRIP	Ø mm	MATERIAL	FEATURES		SECTORS						COLOR	NOTES	CODE		
			AUTOCLAVABLE	CERTIFIED THIRD PARTY APPROVAL											
	40	ZINC-PLATED			•				•	•	•		1 quick-fit fitting	Z7 22121	
		ALUMINIUM			•				•	•	•			Z7 22026	
		STAINLESS STEEL AISI 304	•		•				•	•	•	•		40000215	
		STAINLESS STEEL AISI 316L	•			•	•			•				•	4072200596
			•			•	•			•	■ BLUE			•	4072400398
			•			•	•			•	■ RED			•	4072400399
			•			•	•			•	■ YELLOW			•	4072400400
		•			•	•			•	■ WHITE		•		4072400401	
	•			•	•			•	■ GREEN		•	4072400402			
	STAINLESS STEEL AISI 304	•	•	•				•	•	•	•	for EXA machines	EXA connection	4072000385	
	50	ZINC-PLATED			•				•	•	•		1 quick-fit fitting	Z7 22122	
		ALUMINIUM							•	•	•			Z7 22025	
STAINLESS STEEL AISI 304		•						•	•	•	•	40000222			
STAINLESS STEEL AISI 316L		•		•	•			•			•	4072200597			

4.a Handgrips









HANDGRIP	Ø mm	MATERIAL	FEATURES		SECTORS							COLOR	NOTES	CODE
			AUTOCLAVABLE	CERTIFIED THIRD PARTY APPROVAL										
	50	STAINLESS STEEL AISI 316L	•		•	•					•	BLUE	1 quick-fit fitting	4072400403
			•		•	•					•	RED		4072400404
			•		•	•					•	YELLOW		4072400405
			•		•	•					•	WHITE		4072400406
			•		•	•					•	GREEN		4072400407
	•		•	•			•	•	•	•	•	for EXA machines	EXA connection	4072000386
70	ALUMINIUM	•		•				•	•	•		1 quick-fit fitting	Z7 22091	

The handgrip is essential for cleaning floors; it is the element which fits between the hose sleeve and floor nozzle. It has a quick-fit fitting and is available in various materials and diameters. Coloured versions have an internal flange with a coloured silicone ring.









EXTENSION WITH QUICK-FIT FITTING	Ø mm	MATERIAL	FEATURES		SECTORS							COLOR	NOTES	CODE
			AUTOCLAVABLE	CERTIFIED THIRD PARTY APPROVAL										
	40	ALUMINIUM			•				•	•	•		1 quick-fit fitting, 1 internal flange	Z7 22008
					•				•	•	•			Z7 22007
					•				•	•	•			Z7 22006
					•				•	•	•			Z7 22270
					•				•	•	•			Z7 22267
					•				•	•	•			Z7 22036
	50			•				•	•	•		Z7 22005		
				•				•	•	•		Z7 22004		
				•				•	•	•		Z7 22003		
				•				•	•	•		Z7 22271		
				•				•	•	•		Z7 22268		
				•				•	•	•		Z7 22037		
				•				•	•	•				

The aluminium extensions with quick-fit fittings are available in three different lengths, letting you attach final tools (make sure you remove the harmonic spring, if present) to clean high areas, pipes and walls. Thanks to the internal groove, these extensions can easily be connected together.

4.a Handgrips

EXTENSION WITH QUICK-FIT COUPLING	Ø mm	MATERIAL	FEATURES		SECTORS							COLOR	NOTES	CODE		
			AUTOCLAVABLE	CERTIFIED THIRD PARTY APPROVAL												
	40	ALUMINIUM			•				•	•	•			1 quick-fit coupling with harmonic spring	Z7 22386	
		STAINLESS STEEL AISI 304		•	•				•	•	•	•	•	•	EXA connection for EXA machines	4072400658
	50	ALUMINIUM			•					•	•	•			1 quick-fit coupling with harmonic spring	Z7 22385
		STAINLESS STEEL AISI 304		•	•					•	•	•	•	•	EXA connection for EXA machines	4072400659
	40	PTFE													Resistant to high temperatures. To use with quick-fit extensions with harmonic springs	Z7 20327
	50															Z7 20326
		STAINLESS STEEL AISI 304												For quick-fit coupling	Z7 20328	

The aluminium extensions with quick-fit fittings and harmonic spring are 1 meter long, but can be easily extended as they are easy to fit together, with a hole on one end and a harmonic spring on the other. As well as their use for cleaning suspended parts (e.g. with coloured brushes together with the 50mm coupling, code 4072200388, or the 50/40mm coupling, code 4072200387), when combined with the PTFE sliding sleeve and the floor nozzle with silicone strip (cf. chap. 5.a) they are suitable for cleaning ovens (cf. chap 7, Oven Cleaning Kit).

EXTENSION HANDGRIP FOR IVT1000	Ø mm	MATERIAL	FEATURES		SECTORS							COLOR	NOTES	CODE	
			AUTOCLAVABLE	CERTIFIED THIRD PARTY APPROVAL											
	32	STAINLESS STEEL AISI 316							•					The kit consists of two extensions made of AISI 316 steel	11112500
										•					Connecting tube made of AISI316 steel

The 32mm diameter stainless-steel extensions should only be used with the IVT1000 vacuum cleaner. The two available extensions can easily be connected together (conical type connection). The 250mm long tube (32mm diameter) is also only for the IVT1000. Made of stainless steel, it connects the hose to the final tool/accessory.

CONNECTION DIAGRAMS
 HOSES AND SLEEVES
 HOSE CONNECTORS AND REDUCTIONS
 HANDGRIPS AND EXTENSIONS
 FLOOR NOZZLES AND BRUSHES
 TERMINAL
 ACCESSORIES KIT

4.b Examples: **handgrips** and **extensions**

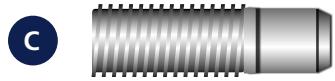

Ø 40 mm
3-meter conductive Flex
Hose with sleeves
Z7 22150

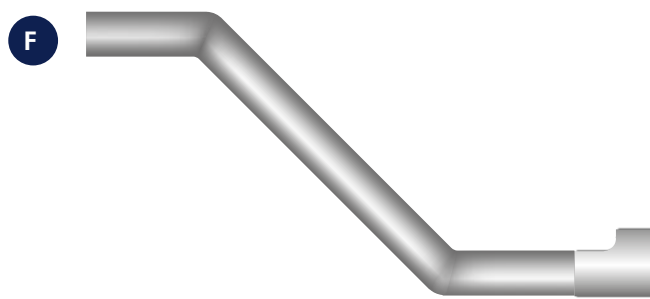

Ø 40 mm
Sleeve
Z7 22121



Ø 40 mm
Wheeled floor nozzle for dust and
liquids (400 mm)
Z7 22030

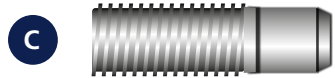

Ø 50 mm
3-meter Air Hose with
sleeves **Z7 22062**
Ø 40 mm
3-meter Air Hose with
sleeves **Z7 22049**



Ø 50 mm
Extensions with quick-fit fitting (3 meters) **Z7 22003**
Ø 40 mm
Extensions with quick-fit fitting (3 meters) **Z7 22006**



Ø 50 mm
Wall brush (400 mm)
Z7 22198

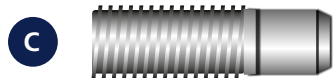

Ø 38 mm
3-meter conductive Flex
Hose with sleeves
Z7 22374



Ø 40 mm
Quick-fit extensions with harmonic spring
Z7 22386



Ø 40 mm
Wall brush (300 mm)
Z7 22194

4.b Examples: handgrips and extensions

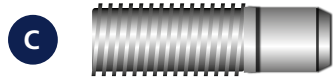

Ø 40 mm
3-meter Air Hose
with sleeves
Z7 22049



Ø 40 mm
Quick-fit extensions with harmonic spring
Z7 22386

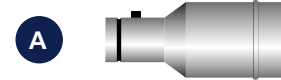

Ø 50/40 mm
Extension fitting
with reduction
4072200387



Ø 50 mm
Curved brush for pipes (300 mm)
22432600

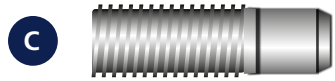

Ø 50 mm
3-meter Polyurethane
Hose with sleeves
Z7 22298



Ø 50 mm
Quick-fit extensions with harmonic spring
Z7 22385



Ø 50 mm
Extension fitting
with reduction
4072200388



Ø 50 mm
Brush for flat surfaces (300 mm)
22432905

4.b Examples: handgrips and extensions

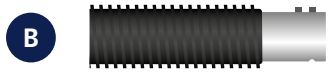

B
Ø 40 mm
3-meter Flex Conductive
Hose
4072400451

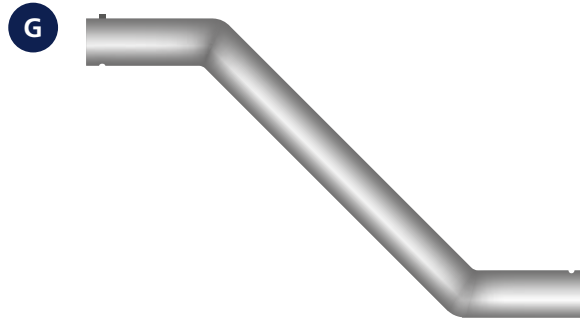

G
Ø 40 mm
EXA handgrip
4072000385



K
Ø 40 mm
Wheeled floor nozzle for dust and
liquids (400 mm)
4072000387



B
Ø 40 mm
3-meter Flex Conductive Hose
4072400451



E
Ø 40 mm
EXA extension
4072400658



K
Ø 40 mm
Mobile coloured floor nozzle (400 mm)
4072400587

Floor nozzles and Brushes

The floor nozzles are used to clean solids and liquids from all types of surfaces. As well as the floor nozzles, brushes are also available to clean dust off floors and other surfaces such as walls and pipes.

The brushes only have bristles, while the floor nozzles have both rubber lips and bristle profiles.

Most Nilfisk floor nozzles and brushes come with certifications (e.g. FDA approval).













5.a Floor nozzles

MOBILE FLOOR NOZZLE FOR DUST AND LIQUIDS	Ø mm	LENGTH millimeters	MATERIAL	FEATURES		SECTORS							COLOR	NOTES	CODE	
				AUTOCLAVABLE	CERTIFIED THIRD PARTY APPROVAL	⚙️	🔧	🔒	🚰	🏭	🏠	⚡				
	40	300	ZINC-PLATED			•				•		•		With two rubber lips (silicone for the stainless steel version), wheel adjuster screw and 1 internal flange	Z7 22171	
		400				•				•		•	Z7 22030			
		400	ZINC-PLATED + SILICONE LIPS						•	•				Anti-Shock Version With Silicone Lips	4072200651	
		400	STAINLESS STEEL													40000216
		400			•	•					•	•	•	for EXA machines	With two rubber lips (silicone for the stainless steel version), wheel adjuster screw and 1 internal flange	4072000387
	50	300	ZINC-PLATED													Z7 22172
		400														Z7 22029
		400	ZINC-PLATED + SILICONE LIPS								•	•			Anti-Shock Version With Silicone Lips	4072200650
		400	STAINLESS STEEL													40000223
		400			•	•					•	•	•	for EXA machines	With two rubber lips (silicone for the stainless steel version), wheel adjuster screw and 1 internal flange	4072000388
500		ZINC-PLATED													Z7 22147	
70	500													Z7 22092		
40														Z8 20123		
	300/400	RUBBER (rubber lips 10 pieces)													Z8 20295	
	500														Z8 20296	

The wheeled floor nozzle, with rubber profile on the zinc-plated version and silicone profile on the stainless steel version, is ideal for cleaning dust and liquids. Thanks to the internal flange it is very easy to connect to the handgrips (cf. chapter 4.a). The new anti-shock versions have been implemented to be used in the B&C sector in order to dissipate any static charges caused by the passage of dust.

CONNECTION DIAGRAMS
 HOSES AND SLEEVES
 HOSE CONNECTORS AND REDUCTIONS
 HANDGRIPS AND EXTENSIONS
 FLOOR NOZZLES AND BRUSHES
 TERMINALI
 ACCESSORIES KIT

5.a Floor nozzles

MOBILE COLOURED NOZZLES FOR DUST AND LIQUIDS	Ø mm	LENGTH millimeters	MATERIAL	FEATURES		SECTORS								COLOR	NOTES	CODE
				AUTOCLAVABLE	CERTIFIED THIRD PARTY APPROVAL											
 	40	400	AISI 316 + SILICONE FDA COVER	•		•	•							TRANSPARENT	EXA connection	4072400314
				•		•	•							BLUE		4072400315
				•		•	•							RED		4072400316
				•		•	•							GREEN		4072400317
				•		•	•							YELLOW		4072400318
				•		•	•							WHITE		4072400319
				•		•	•							TRANSPARENT		4072400320
				•		•	•							BLUE		4072400321
				•		•	•							RED		4072400322
				•		•	•							GREEN		4072400323
	50	400	AISI 316 + SILICONE FDA COVER	•		•	•								YELLOW	4072400324
				•		•	•								WHITE	4072400325
				•	•	•	•							TRANSPARENT	4072400587	
				•	•	•	•							BLUE	4072400588	
				•	•	•	•							RED	4072400589	
				•	•	•	•							GREEN	4072400590	
				•	•	•	•							YELLOW	4072400591	
				•	•	•	•							WHITE	4072400592	
				•	•	•	•							TRANSPARENT	4072400593	
				•	•	•	•							BLUE	4072400594	
40	400	AISI 316 + SILICONE FDA COVER	•	•	•	•								RED	4072400595	
			•	•	•	•							GREEN	4072400596		
			•	•	•	•							YELLOW	4072400597		
			•	•	•	•							WHITE	4072400598		
			•	•	•	•							TRANSPARENT	4082300062		
			•	•	•	•							BLUE	4082300063		
			•	•	•	•							RED	4082300064		
			•	•	•	•							GREEN	4082300065		
			•	•	•	•							YELLOW	4082300066		
			•	•	•	•							WHITE	4082300067		
			Silicone wheel												4082300061	

The coloured floor nozzle can be used to apply the colour coded program in the food & pharma sectors.

5.a Floor nozzles

COLOURED NOZZLE	Ø mm	LENGTH millimeters	MATERIAL	FEATURES		SECTORS							COLOR	NOTES	CODE			
				AUTOCLAVABLE	CERTIFIED THIRD PARTY APPROVAL													
	40	400	AISI 316 + NBR FDA COVER				•	•						BLUE		4072400304		
							•	•							RED		4072400305	
							•	•								GREEN		4072400306
							•	•								YELLOW		4072400307
							•	•								WHITE		4072400308
	50	400	AISI 316 + NBR FDA COVER				•	•							BLUE		4072400309	
							•	•							RED		4072400310	
							•	•								GREEN		4072400311
							•	•								YELLOW		4072400312
							•	•								WHITE		4072400313
		SILICONE				•	•							Silicone lip	Z8 20255			











Stainless steel nozzle with coloured cover to be used in the food sector to apply the colour coded program.

WHEELED FLOOR NOZZLE FOR DUST	Ø mm	LENGTH millimeters	MATERIAL	FEATURES		SECTORS							COLOR	NOTES	CODE			
				AUTOCLAVABLE	CERTIFIED THIRD PARTY APPROVAL													
	40	300	ZINC-PLATED				•			•		•				Z7 22174		
		400					•			•		•				Z7 22138		
	50	300					•			•		•				With two brush lips, wheel adjuster screw and 1 internal flange	Z7 22175	
		400					•			•		•				Z7 22137		
		500					•			•		•				Z7 22148		
	70	500					•			•		•				Z7 22149		
		300/400	BRUSH STRIPS														Brush strips (10 pieces)	Z8 23040
		500															Z8 23041	









The wheeled floor nozzle with bristle profile is ideal for cleaning dust. Thanks to the internal flange it is very easy to connect to the handgrips (cf. chapter 4.a).

CONNECTION DIAGRAMS
 HOSES AND SLEEVES
 HOSE CONNECTORS AND REDUCTIONS
 HANDGRIPS AND EXTENSIONS
 FLOOR NOZZLES AND BRUSHES
 TERMINALI
 ACCESSORIES KIT

5.a Floor nozzles









NOZZLE FOR OVENS	Ø mm	LENGTH millimeters	MATERIAL	FEATURES		SECTORS							COLOR	NOTES	CODE
				AUTOCLAVABLE	CERTIFIED THIRD PARTY APPROVAL										
	40	400	ZINC-PLATED			•	•						•	With two silicone lips, wheel adjuster screw, 1 internal flange and harmonic spring quick-fit coupling	Z7 22272
	50					•	•								•
	40	400	ALUMINIUM			•	•						•	1 internal flange and 1 quick-fit coupling with harmonic spring	Z7 22031
	50					•	•								•
	40	400	AISI 316 BASE WITH HEAT RESISTANT COVER										•	1 internal flange	4072400326
	50														•
		500	SILICONE											Silicone lip	Z8 20255

The nozzles for cleaning ovens are special components resistant to high temperatures. There are two versions available: the first has wheels and silicone lips, the second is made completely of aluminium. Both have quick-fit couplings with harmonic spring so they can easily be connected to the extensions, which also have harmonic spring quick-fit couplings, as shown in chapter 4.b.









NOZZLE FOR BUSES	Ø mm	LENGTH millimeters	MATERIAL	FEATURES		SECTORS							COLOR	NOTES	CODE
				AUTOCLAVABLE	CERTIFIED THIRD PARTY APPROVAL										
	50	200	ALUMINIUM			•							•	"C" bristle profile and 1 internal flange	Z7 22170

The nozzle for buses, thanks to its compact dimensions and "C" bristle profile is ideal for cleaning the corridors of buses. Made entirely of aluminium, it has an internal flange for the quick-fit coupling with the relevant handgrip (cf. chapter 4.a).

5.a Floor nozzles

FLOOR NOZZLE FOR LIQUIDS	Ø mm	LENGTH millimeters	MATERIAL	FEATURES		SECTORS							COLOR	NOTES	CODE
				AUTOCLAVABLE	CERTIFIED THIRD PARTY APPROVAL										
	40	400	ZINC-PLATED			•						•	With two lips made of rubber (silicone for the stainless steel version), two Nylon shoes and 1 internal flange	Z7 22028	
			STAINLESS STEEL			•						•		Z7 22296	
		500	ZINC-PLATED			•						•		Z7 22168	
	50	400	ZINC-PLATED			•						•		Z7 22027	
			STAINLESS STEEL			•						•		Z7 22294	
		500	ZINC-PLATED			•						•		Z7 22167	
		400	RUBBER LIPS			•						•	Rubber lip	Z8 20086	
		500	RUBBER LIPS											Z8 20087	



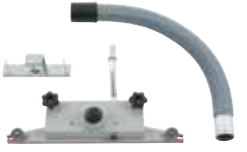





The floor nozzles for liquids are suitable for cleaning liquids off floors. They have two rubber lips, or silicone lips on the stainless steel versions. They are easy to connect to the handgrips thanks to the internal groove on the fitting of the floor nozzle.

FIXED FLOOR NOZZLE	Ø mm	LENGTH millimeters	MATERIAL	FEATURES		SECTORS							COLOR	NOTES	CODE	
				AUTOCLAVABLE	CERTIFIED THIRD PARTY APPROVAL											
	70	600	ZINC-PLATED			•						•	With two lips made of rubber and two wheels	Z7 22085		
						•								•	For S2/S3 model	4056000487
						•									•	For CTS model
		700	ZINC-PLATED			•						•	With two lips made of rubber and two wheels	Z7 22086		
	50	500	ZINC-PLATED			•						•	For D400 Platform	4072200695		
			RUBBER											Rubber lip 600-700 mm	Z8 20297	











The fixed floor nozzle is a special floor nozzle ideal for cleaning dust on large surface areas. The fixed floor nozzle has two rubber lips and two wheels. It is very easy to connect it to the vacuum cleaner thanks to the 70mm diameter quick-fit fitting.

CONNECTION DIAGRAMS
 HOSES AND SLEEVES
 HOSE CONNECTORS AND REDUCTIONS
 HANDGRIPS AND EXTENSIONS
 FLOOR NOZZLES AND BRUSHES
 TERMINAL
 ACCESSORIES KIT

5.a Floor nozzles

FLOOR NOZZLE FOR IVT1000	Ø mm	LENGTH millimeters	MATERIAL	FEATURES		SECTORS							COLOR	NOTES	CODE
				AUTOCLAVABLE	CERTIFIED THIRD PARTY APPROVAL										
	32	300	STAINLESS STEEL + POLYPROPYLENE	•				•						Bristle profile and stainless steel coupling	22431611
				•				•							22431608
				•				•							
<p>These three floor nozzles are designed specifically for the IVT1000 vacuum cleaner. As well as the standard version and the antistatic version there is also a model with a silicone profile, approved by the FDA and suitable for autoclaves. All three floor nozzles are suitable for cleaning dust.</p>															









5.b Brushes

BRUSH	Ø mm	LENGTH millimeters	MATERIAL	FEATURES		SECTORS							COLOR	NOTES	CODE		
				AUTOCLAVABLE	CERTIFIED THIRD PARTY APPROVAL												
	40	220	PVC BRUSH + METAL CONNECTION			•						•			Z7 22042		
		300				•						•			Z7 22043		
		400				•						•			Z7 22044		
	50	220					•						•			Z7 22038	
		300					•						•			Z7 22039	
		400					•						•			Z7 22040	
		500					•						•			Z7 22041	
	70	300					•						•			Z7 22077	
		400					•						•			Z7 22078	
		500					•						•			Z7 22093	
		40		220	PVC BRUSH + METAL CONNECTION			•						•			Z7 22193
				300				•						•			Z7 22194
400						•						•			Z7 22195		
50		220					•						•			Z7 22196	
		300					•						•			Z7 22197	
		400					•						•			Z7 22198	
		500					•						•			Z7 22199	
		220					•						•			Z8 23009	
		300					•						•			Z8 23010	
		400					•						•			Z8 23011	
		500					•						•			Z8 23012	









The rectangular-section 90° brushes are ideal for removing and cleaning dust from floors, while the 30° brushes are ideal for cleaning walls. Both types, with a PVC structure, have a black bristle profile. The 90° brushes connect to the handgrips described in chapter 4.a, while the wall brushes connect to the extensions described in chapter 4.b (in particular, when used with the quick-fit extensions, remember to always remove the harmonic spring from the brushes).

CONNECTION DIAGRAMS
 HOSES AND SLEEVES
 HOSE CONNECTORS AND REDUCTIONS
 HANDGRIPS AND EXTENSIONS
 FLOOR NOZZLES AND BRUSHES
 TERMINALI
 ACCESSORIES KIT

5.b Brushes

CURVED BRUSH FOR PIPES	Ø mm	LENGTH millimeters	MATERIAL	FEATURES		SECTORS							COLOR	NOTES	CODE
				AUTOCLAVABLE	CERTIFIED THIRD PARTY APPROVAL										
	40	100	PVC BRUSH			•						•		CURVED BRUSH FOR PIPES: bristle profile, 1 internal flange and quick-fit coupling with harmonic spring	Z7 22132
		200				•						•	Z7 22134		
	50	100				•						•	Z7 22131		
		200				•						•	Z7 22133		
		100				•						•	CURVED BRUSH SPARE PARTS: the quick-fit coupling with harmonic spring is not included	Z8 24042	
		200				•						•		Z8 24043	

The curved brush is designed for cleaning pipes, especially in suspended installations. Its rounded shape makes it particularly effective for removing and cleaning dust. This element must be used with the extensions described in chapter 4.b (in particular, when used with the quick-fit extensions, remember to always remove the harmonic spring from the brushes).

NOZZLE FOR FLAT SURFACES	Ø mm	LENGTH millimeters	MATERIAL	FEATURES		SECTORS							COLOR	NOTES	CODE
				AUTOCLAVABLE	CERTIFIED THIRD PARTY APPROVAL										
	50	300	POLYPROPYLENE									•	NOZZLE FOR FLAT SURFACES: with lip made of rubber, suitable for autoclaves, FDA approved, green	22432306	
	50	300											•	NOZZLE FOR FLAT SURFACES: with rubber lip, FDA approved, black	22432302
		300											•	NOZZLE SPARE PART: green, the floor nozzle fitting is not included	32430806
		300											•	NOZZLE SPARE PART: black, the floor nozzle fitting is not included	32430802
				ZINC-PLATED									•	NOZZLE FITTING SPARE PART: swivel fitting	10645031
				STAINLESS STEEL									•		10645011

The coloured nozzles for flat surfaces with rubber lip are specific nozzles for environments where foodstuffs and pharmaceuticals are processed (in particular for cleaning high areas). Available in the autoclave and conductive versions, all FDA approved, these nozzles come in three colours: green, grey and black (conductive version). Thanks to the swivel fitting (to connect to quick-fit extensions with harmonic spring using the 50/40mm reduction, code 4072200387, or with a 50mm extension fitting, code 4072200388), the manoeuvrability and functionality are unbeatable.

5.b Brushes

BRUSH FOR FLAT SURFACES	Ø mm	LENGTH millimeters	MATERIAL	FEATURES		SECTORS								COLOR	NOTES	CODE				
				AUTOCLAVABLE	CERTIFIED THIRD PARTY APPROVAL															
	50	300	POLYPROPYLENE													BRUSH FOR FLAT SURFACES: bristle profile, FDA approved, black	22432902			
																		BRUSH FOR FLAT SURFACES: bristle profile, FDA approved, grey	22432900	
																			BRUSH FOR FLAT SURFACES: bristle profile, suitable for autoclaves, FDA approved, blue	22432907
																			BRUSH FOR FLAT SURFACES: bristle profile, suitable for autoclaves, FDA approved, red	22432905
																			BRUSH FOR FLAT SURFACES: bristle profile, suitable for autoclaves, FDA approved, green	22432906
																			BRUSH SPARE PARTS: black, the floor nozzle fitting is not included	42431602
																			BRUSH SPARE PARTS: blue, the floor nozzle fitting is not included	42431607
																			BRUSH SPARE PARTS: red, the floor nozzle fitting is not included	42431605
																			BRUSH SPARE PARTS: green, the floor nozzle fitting is not included	42431606
																BRUSH SPARE PARTS: yellow, the floor nozzle fitting is not included	42431604			
	50		ZINC-PLATED																	
			STAINLESS STEEL																	
<p>The coloured brushes for flat surfaces, with a bristle profile, are also designed for cleaning environments where foodstuffs and pharmaceuticals are processed, especially for cleaning high areas. These brushes, available in various colours, are suitable for autoclaves and are FDA approved. With a swivel fitting, these brushes must be used with quick-fit extensions with harmonic spring and the relevant fittings (with 50/40mm reduction and harmonic spring or 50mm fitting with harmonic spring).</p>																				

CURVED BRUSH FOR PIPES	Ø mm	LENGTH millimeters	MATERIAL	FEATURES		SECTORS								COLOR	NOTES	CODE		
				AUTOCLAVABLE	CERTIFIED THIRD PARTY APPROVAL													
	50	100	POLYPROPYLENE														22432402	
		200																22432502
		300																22432602
	100																	42430902
	200																	42431002
	300																	42431102
		50		ZINC-PLATED														
			STAINLESS STEEL															
<p>The curved, coloured brushes for pipes, with a bristle profile, are ideal for cleaning dust off pipes in suspended installations. Available in two colours, grey and black (conductive version), and in three sizes, they are FDA approved. With a swivel fitting, these brushes must be used with quick-fit extensions with harmonic spring and the relevant fittings (with 50/40mm reduction and harmonic spring or 50mm fitting with harmonic spring).</p>																		

CONNECTION DIAGRAMS
HOSES AND SLEEVES
HOSE CONNECTORS AND REDUCTIONS
HANDGRIPS AND EXTENSIONS
FLOOR NOZZLES AND BRUSHES
TERMINALI
ACCESSORIES KIT

5.c Examples: **Floor nozzles** and **Brushes**

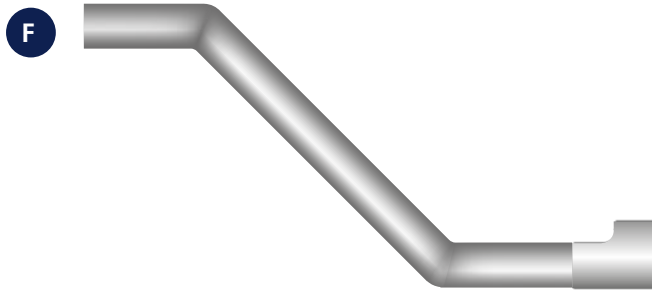

Ø 40 mm
Handgrip
Z7 22121



Ø 40 mm
Floor nozzle for liquids (400 mm) **Z7 22296**
Ø 40 mm
Wheeled floor nozzle for dust (500 mm) **Z7 22138**

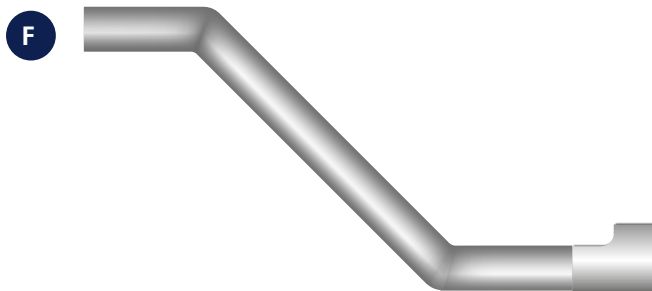

Ø 50 mm
Handgrip
40000222



Ø 50 mm
Floor brush (300 mm)
Z7 22039

5.c Examples: Floor nozzles and Brushes



Ø 40 mm

Quick-fit extensions with harmonic spring

Z7 22386

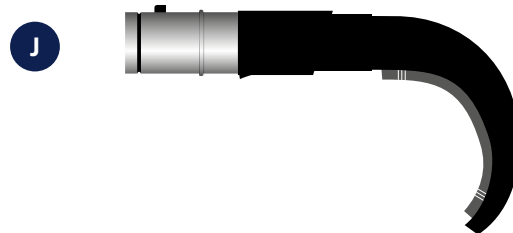

Ø 40 mm

Curved brush for pipes (200 mm)

Z7 22134



Ø 40 mm

Quick-fit extensions with harmonic spring

7 22386



Ø 40/50 mm

Extension fitting

with reduction
4072200387



Ø 50 mm

Nozzle for flat surfaces (300 mm)

22432302



Ø 50 mm

Quick-fit extensions with harmonic spring

7 22385

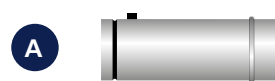

Ø 50 mm

Extension fitting

4072200388



Ø 50 mm

Nozzle for flat surfaces (300 mm)

22432302

5.c Examples: Floor nozzles and Brushes

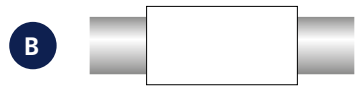

B

Ø 40 mm

Sliding PTFE sleeve

7 20327



D

Ø 40 mm

Quick-fit extensions with harmonic spring

7 22386



K

Ø 40 mm

Wheeled nozzle for ovens (400 mm)

7 22272



K

Ø 40 mm

Nozzle for ovens (400 mm)

7 22031

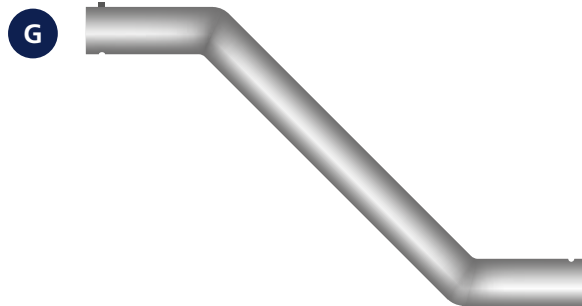

G

Ø 40 mm

EXA handgrip

4072000385



K

Ø 40 mm

Mobile coloured floor nozzle (400 mm)

4072400587



Final tools

All the final tools/accessories such as rubber and antistatic rubber cones, natural- and Nylon-bristle round brushes, zinc-plated and stainless-steel flat-tip crevice nozzles are grouped together in the category “Final tools”.



Successful cleaning also depends on these elements.



6.a Rubber tools











CONE	Ø mm	MATERIAL	FEATURES		SECTORS							COLOR	NOTES	CODE		
			AUTOCLAVABLE	CERTIFIED THIRD PARTY APPROVAL												
  	40	NBR			•				•	•	•	•			Z7 21011	
		CONDUCTIVE NBR			•					•	•	•	•			40000214
		STAINLESS STEEL + CONDUCTIVE NBR		•	•	•				•	•	•	•	• for EXA machines	Oilproof	4072400505
		SILICONE	•			•	•							•	TRANSPARENT	4072100105
			•			•	•							•	BLUE	4072100106
			•			•	•							•	RED	4072100107
			•			•	•							•	GREEN	4072100108
			•			•	•							•	YELLOW	4072100109
			•			•	•							•	WHITE	4072100110
		STAINLESS STEEL AISI 304 + SILICONE	•			•	•							•	TRANSPARENT	4072400507
			•			•	•							•	BLUE	4072400508
			•			•	•							•	RED	4072400509
•			•	Only dust, II 2D	•	•						•	GREEN	4072400510		
•					•	•						•	YELLOW	4072400511		
•					•	•						•	WHITE	4072400512		









6.a Rubber tools

CONE	Ø mm	MATERIAL	FEATURES		SECTORS							COLOR	NOTES	CODE			
			AUTOCLAVABLE	CERTIFIED THIRD PARTY APPROVAL													
  	50	NBR														Z7 21010	
														GREY	Length 245 mm, GREY	80650900	
															GREY	Length 500 mm, GREY	80691100
		CONDUCTIVE NBR															40000221
		STAINLESS STEEL + CONDUCTIVE NBR		•											• for EXA machines	Oilproof	4072400506
		SILICONE	•												TRANSPARENT		4072100111
			•												BLUE		4072100112
			•												RED		4072100113
			•												GREEN		4072100114
			•												YELLOW		4072100115
	•													WHITE		4072100116	
	STAINLESS STEEL AISI 304 + SILICONE	•					•	•						TRANSPARENT		4072400513	
		•					•	•						BLUE		4072400514	
		•					•	•						RED		4072400515	
		•		• Only dust, II 2D			•	•						GREEN		4072400516	
		•					•	•						YELLOW		4072400517	
		•					•	•						WHITE		4072400518	
	70	NBR					•	•	•	•	•						Z7 21009

The black nitrile rubber cones are the conductive model, while the red ones are standard. They are oil-resistant and therefore suitable for cleaning shavings and liquids from machine tools. The length varies from 200mm to a maximum of 500mm. The silicone version, available only with a 40mm diameter, is suitable for autoclaves. These cones can be connected both to junction fittings and curved fittings. Coloured silicone versions are FDA approved and suitable for the food sector. They are all provided with metal connectors with the pushbutton already mounted. This metal connection will keep the same diameter of the terminal tool. Coloured tools have been tested to be used in zone 22 ATEX classified areas, so it means they can collect dust. The use of these accessories in zone 22 ATEX environment is allowed only if they are connected to an antistatic or dissipative flex hose by means of stainless steel metal parts, all provided by Nilfisk.

6.a Rubber tools

CONICAL TOOL D32	Ø mm	MATERIAL	FEATURES		SECTORS							COLOR	NOTES	CODE		
			AUTOCLAVABLE	CERTIFIED THIRD PARTY APPROVAL												
	32	NBR			•							•	 GREY		81141101	
		CONDUCTIVE NBR			•							•	•	 BLACK		81932600
		SILICONE	•		•	•	•							TRANSPARENT WHITE		81141103
	40	STAINLESS STEEL + CONDUCTIVE NBR			•	•						•	• for EXA machines	 BLACK	With reduction 40/32	4072400520
					•	•					•	•		With reduction 40/32 and with bristles on the top of the tool	4072400599	
	<p>The 240mm final cone is for use on the IVT1000 vacuum cleaner. Three versions are available: standard, anti-static and autoclave-safe (in silicone). They must always be used with the connecting tube (code 11882505) The certified and marked version is available both with bristles and without.</p>															

50/20 CONICAL TOOL	Ø mm	MATERIAL	FEATURES		SECTORS							COLOR	NOTES	CODE	
			AUTOCLAVABLE	CERTIFIED THIRD PARTY APPROVAL											
	40	ZINC-PLATED + CONDUCTIVE NBR			•							•		Supplied With 50/40 mm Reduction	Z7 22142
	50					•						•		Supplied with 50 mm Junction Fitting	Z7 22141
		STAINLESS STEEL + CONDUCTIVE NBR			•							•		Supplied with 50 mm stainless steel junction fitting	4072400416
		ANTISTATIC NBR			•							•		CURVED TIP (the fitting and the reduction are not included)	Z8 24046
		NBR			•									Optional spare part: straight shape (the fitting and the reduction are not included)	82167400
<p>The 50/20 final cones are 300 mm long and are generally used to clean dust and thread-like residue.</p>															









CONNECTION DIAGRAMS
 HOSES AND SLEEVES
 HOSE CONNECTORS AND REDUCTIONS
 HANDGRIPS AND EXTENSIONS
 FLOOR NOZZLES AND BRUSHES
 TERMINALI
 ACCESSORIES KIT

6.a Rubber tools

SILICONE CONICAL TOOL	Ø mm	MATERIAL	FEATURES		SECTORS							COLOR	NOTES	CODE		
			AUTOCLAVABLE	CERTIFIED THIRD PARTY APPROVAL												
	40	FDA SILICONE	•			•	•						TRANSPARENT		4072100129	
			•			•	•						BLUE		4072100130	
			•			•	•						RED		4072100131	
			•			•	•						GREEN		4072100132	
			•			•	•						YELLOW		4072100133	
			•			•	•						WHITE		4072100134	
			STAINLESS STEEL AISI304 + FDA SILICONE	•	• Only dust, II 2D		•	•				• for EXA machines		TRANSPARENT		4072400534
				•			•	•			BLUE			4072400535		
				•			•	•			RED			4072400536		
				•			•	•			GREEN			4072400537		
				•			•	•			YELLOW			4072400538		
				•			•	•			WHITE			4072400539		















The silicone conical tool is available only in D40. This shape can be modified by cutting the tip of the nozzle thanks to predefined internal flanges. These final tools can be connected both to junction fittings and curved fittings.









6.a Rubber tools

RUBBER NOZZLE	Ø mm	MATERIAL	FEATURES		SECTORS							COLOR	NOTES	CODE		
			AUTOCLAVABLE	CERTIFIED THIRD PARTY APPROVAL												
 	40	SILICONE	•		•	•						TRANSPARENT		4072100117		
			•		•	•						■ BLUE		4072100118		
			•		•	•						■ RED		4072100119		
			•		•	•						■ GREEN		4072100120		
			•		•	•						■ YELLOW		4072100121		
			•		•	•						■ WHITE		4072100122		
		STAINLESS STEEL AISI 304 + SILICONE	Only dust, II 2D	•	•		•	•					• for EXA machines	TRANSPARENT		4072400522
					•		•	•					■ BLUE		4072400523	
					•		•	•					■ RED		4072400524	
					•		•	•					■ GREEN		4072400525	
					•		•	•					■ YELLOW		4072400526	
					•		•	•					■ WHITE		4072400527	
	50	NBR	CONDUCTIVE NBR			•			•	•	•		■ GREY	120 mm	27 21030	
						•			•	•	•	•	■ BLACK		27 21080	
		SILICONE	•		•	•							TRANSPARENT		4072100123	
			•		•	•						■ BLUE		4072100124		
			•		•	•						■ RED		4072100125		
			•		•	•						■ GREEN		4072100126		
•				•	•						■ YELLOW		4072100127			
•				•	•						■ WHITE		4072100128			
STAINLESS STEEL + CONDUCTIVE NBR		•	•	•	•	•	•	•	•	•		• for EXA machines	■ BLACK	120 mm	4072400519	
		•	•	•			•	•	•				■ BLACK	200 mm	4072400521	
STAINLESS STEEL AISI 304 + SILICONE		•	•	•	•							• for EXA machines	TRANSPARENT		4072400528	
			Only dust, II 2D	•	•								■ BLUE		4072400529	

CONNECTION DIAGRAMS
 HOSES AND SLEEVES
 HOSE CONNECTORS AND REDUCTIONS
 HANDGRIPS AND EXTENSIONS
 FLOOR NOZZLES AND BRUSHES
 TERMINALI
 ACCESSORIES KIT

6.a Rubber tools

RUBBER NOZZLE	Ø mm	MATERIAL	FEATURES		SECTORS							COLOR	NOTES	CODE	
			AUTOCLAVABLE	CERTIFIED THIRD PARTY APPROVAL											
		STAINLESS STEEL AISI 304 + SILICONE		Only dust, II 2D								■ RED		4072400530	
												■ GREEN		4072400531	
												■ YELLOW		4072400532	
												■ WHITE		4072400533	
	50	NBR			•			•	•	•		■ GREY	200 mm	80640500	
		CONDUCTIVE NBR			•			•	•	•		■ BLACK		80640501	
		PVC			•			•	•	•		■ BLACK		82167300	
	<p>The rubber floor nozzle is ideal for removing shavings and dust, thanks to its toothed profile; it is available in a grey standard version and a black conductive version. The floor nozzle must be used with a 50/40mm reduction or a 50mm junction fitting. Alternatively, it can be used with a curved fitting and a 50/40mm reduction or a 50mm curved fitting. The PVC oilproof nozzle (25mm x 90mm) is a special nozzle in this group.</p>														

CREVICE NOZZLES	Ø mm	MATERIAL	FEATURES		SECTORS							COLOR	NOTES	CODE		
			AUTOCLAVABLE	CERTIFIED THIRD PARTY APPROVAL												
 	32	STAINLESS STEEL AISI 304	•			•	•							For IVT1000, 250mm long	80552000	
	40	ZINC-PLATED				•		•	•	•					1 external flange	Z7 21027
						•			•	•	•					Z7 22022
		PVC				•			•	•	•				500mm	Z7 24014
		STAINLESS STEEL AISI 304				•			•	•	•				1 external flange	40000213
		STAINLESS STEEL AISI 316L	•			•	•									4072100148
		STAINLESS STEEL AISI 316L + SILICONE	•				•	•						■ BLUE		4072400388
			•				•	•						■ RED		4072400389
			•				•	•						■ GREEN	1 Internal flange and silicone ring	4072400390
	•					•	•						■ YELLOW		4072400391	
•				•	•						■ WHITE		4072400392			

6.a Rubber tools

CREVICE NOZZLES	Ø mm	MATERIAL	FEATURES		SECTORS							COLOR	NOTES	CODE	
			AUTOCLAVABLE	CERTIFIED THIRD PARTY APPROVAL											
	40	STAINLESS STEEL AISI 304		•								• for EXA machines	EXA connection	4072100162	
		50	ZINC-PLATED			•			•	•	•			1 external flange	Z7 21026
					•			•	•	•			1 internal flange	Z7 21074	
					•			•	•	•				1 external flange	Z7 22021
					•			•	•	•				1 external flange	Z7 21075
		PVC			•			•	•	•			500mm	Z7 24013	
		STAINLESS STEEL AISI 304			•			•	•	•			1 external flange	40000220	
		STAINLESS STEEL AISI 316L	•			•	•							4072100149	
		STAINLESS STEEL AISI 316L + SILICONE	•			•	•					■ BLUE	Internal flange and silicone ring	4072400393	
			•			•	•					■ RED		4072400394	
			•				•	•				■ GREEN		4072400395	
	•					•	•				■ YELLOW	4072400396			
	•					•	•				■ WHITE	4072400397			
	70	STAINLESS STEEL AISI 304		•	•			•	•	•	• for EXA machines	EXA connection	4072100163		
	70	ZINC-PLATED			•			•	•	•			1 external flange	Z7 21028	
		PVC			•			•	•	•			1000mm	Z7 24012	

The crevice nozzles, made of metal and PVC are ideal for cleaning shavings, dust and liquids. In particular, the flat-tip crevice nozzles are the best tool for cleaning in corners, while the ones with perimeter brush effectively remove and clean dust. Metal flat-tip crevice nozzles are also available for special requirements, curved and with reductions. Coloured versions are available with an internal flange with a silicone coloured ring for the food sector.

CONNECTION DIAGRAMS
 HOSES AND SLEEVES
 HOSE CONNECTORS AND REDUCTIONS
 HANDGRIPS AND EXTENSIONS
 FLOOR NOZZLES AND BRUSHES
 TERMINALI
 ACCESSORIES KIT

6.a Rubber tools

CREVICE NOZZLES WITH BRUSH	Ø mm	MATERIAL	FEATURES		SECTORS							COLOR	NOTES	CODE	
			AUTOCLAVABLE	CERTIFIED THIRD PARTY APPROVAL											
	40	ZINC-PLATED			•			•	•	•			Steel perimeter brush	Z7 22024	
					•			•	•	•			Nylon perimeter brush	Z7 22088	
	50				•				•	•	•			Steel perimeter brush	Z7 22023
					•				•	•	•			Nylon perimeter brush	Z7 22089
Three crevice nozzle with brush is ideal for cleaning sticky material that must be removed from the surface. Both steel and nylon brushes are available.															

CREVICE NOZZLES WITH HANDLES	Ø mm	MATERIAL	FEATURES		SECTORS							COLOR	NOTES	CODE
			AUTOCLAVABLE	CERTIFIED THIRD PARTY APPROVAL										
	70	ALUMINIUM			•			•	•	•				Z7 22169
	100				•			•	•	•				Z7 22190
Aluminium crevice nozzles with handles are recommended For more heavy-duty use.														

FLUIDIFYING NOZZLE	Ø mm	MATERIAL	FEATURES		SECTORS							COLOR	NOTES	CODE
			AUTOCLAVABLE	CERTIFIED THIRD PARTY APPROVAL										
	40	ZINC-PLATED			•			•	•	•				Z7 22053
					•			•	•	•				Z7 22054
	50	ALUMINIUM			•			•	•	•				ZA7210024
					•			•	•	•				Z7 22055
	70	ZINC-PLATED			•			•	•	•				ZA7210026
					•			•	•	•				ZA7210019
100	ALUMINIUM			•			•	•	•				ZA7210019	
The fluidifying tools are normally used when you have to clean a notable quantity of material, both scattered dust and heaps of dust. Thanks to the particular construction, with a double concentric tube, the fluidifying tool, with or without regulator, is very efficient during the suction phase.														











6.a Rubber tools

SCRAPER NOZZLES	Ø mm	MATERIAL	FEATURES		SECTORS							COLOR	NOTES	CODE
			AUTOCLAVABLE	CERTIFIED THIRD PARTY APPROVAL										
	40	ZINC-PLATED			•			•	•	•			Length 1000mm - Width 110mm	Z7 22033
		STAINLESS STEEL AISI 304			•			•	•	•				Z7 22277
	50	ZINC-PLATED			•			•	•	•			Length 1000mm - Width 150mm	Z7 22034
		STAINLESS STEEL AISI 304		•	•			•	•	•		• for EXA machines		Z7 22278
	70	ZINC-PLATED			•			•	•	•			Length 1000mm - Width 200mm	Z7 22090
The scraper nozzles, available in various widths and one length (1000mm), are ideal for scraping and vacuuming floors. Also EXA version is available.														





ROUND BRUSHES	Ø mm	MATERIAL	FEATURES		SECTORS							COLOR	NOTES	CODE	
			AUTOCLAVABLE	CERTIFIED THIRD PARTY APPROVAL											
	40	ZINC-PLATED			•			•	•	•			With nylon bristles, 1 internal flange and 1 quick-fit coupling with harmonic spring	Z7 22045	
					•			•	•	•				Z7 22046	
	50				•				•	•	•				Z7 22047
							•			•	•	•			
		NYLON BRISTLES												With nylon bristles, for round brush with D40	Z8 23005
														With nylon bristles, for round brush with D50	Z8 23006
	STEEL BRISTLES												with steel bristles, for round brushes with D40 and D50	Z8 23008	
Round brushes are generally used to clean dust. They can be connected directly to a hose using the relevant sleeve or can be connected to the extensions shown in chapter 4.b (in particular if used with quick-fit extensions, remember to always remove the harmonic spring from the fitting of the round brushes).															

CONNECTION DIAGRAMS
 HOSES AND SLEEVES
 HOSE CONNECTORS AND REDUCTIONS
 HANDGRIPS AND EXTENSIONS
 FLOOR NOZZLES AND BRUSHES
 TERMINALI
 ACCESSORIES KIT





6.a Rubber tools

CONDUCTIVE ROUND BRUSHES	Ø mm	MATERIAL	FEATURES		SECTORS								COLOR	NOTES	CODE	
			AUTOCLAVABLE	CERTIFIED THIRD PARTY APPROVAL												
  	40	Conductive PVC+nylon+brass										•	■ BLACK	With black nylon bristles and brass bristles	4072400262	
				•									• for EXA machines	■ BLACK	With Stainless Steel EXA connector	4072400540
	50	Conductive PVC+nylon+brass											•	■ BLACK	With black nylon bristles and brass bristles	4072400263
				•									• for EXA machines	■ BLACK	With Stainless Steel EXA connector	4072400541
		Nylon+brass											•		SPARE PART: with nylon and brass bristles for the conductive version of the brush	4072400270
	Conductive round brushes are suitable for ATEX applications. These final tools can be connected both to junction fittings and curved fittings.															

6.a Rubber tools

COLOURED ROUND BRUSHES	Ø mm	MATERIAL	FEATURES		SECTORS							COLOR	NOTES	CODE		
			AUTOCLAVABLE	CERTIFIED THIRD PARTY APPROVAL												
	38	ALUMINIUM			•							•		With polypropylene bristles, wood body with an aluminium fitting, 100mm diameter round brush	10989000	
	50	NBR										•		With natural bristles	12422500	
	40	PVC + POLYPROPYLENE										•	■ BLACK	With black bristles made of polypropylene	4072200576	
												•	■ RED	With red bristles made of polypropylene	4072200577	
													•	■ GREEN	With green bristles made of polypropylene	4072200578
													•	■ BLUE	With blue bristles made of polypropylene	4072200579
													•	■ WHITE	With white bristles made of polypropylene	4072200580
	50												•	■ BLACK	With black bristles made of polypropylene	4072200570
													•	■ RED	With red bristles made of polypropylene	4072200571
													•	■ GREEN	With green bristles made of polypropylene	4072200572
													•	■ BLUE	With blue bristles made of polypropylene	4072200573
													•	■ WHITE	With white bristles made of polypropylene	4072200574
												•	■ YELLOW	With yellow bristles made of polypropylene	4072200575	
	40	POLYPROPYLENE										•		With black bristles made of polypropylene	4072400264	
												•	■ RED	With red bristles made of polypropylene	4072400265	
												•	■ GREEN	With green bristles made of polypropylene	4072400266	
												•	■ BLUE	With blue bristles made of polypropylene	4072400267	
		FDA NBR + NYLON	•				•	•				•	■ BLUE	FDA approved material	4072400274	
		•				•	•			•	■ RED	4072400275				
		•				•	•			•	■ GREEN	4072400276				
		•				•	•			•	■ YELLOW	4072400277				
		•				•	•			•	■ WHITE	4072400278				

6.a Rubber tools

COLOURED ROUND BRUSHES	Ø mm	MATERIAL	FEATURES		SECTORS							COLOR	NOTES	CODE					
			AUTOCLAVABLE	CERTIFIED THIRD PARTY APPROVAL															
   	40	FDA NBR + NYLON	•			•	•						•	BLUE-BLUE	FDA approved material-blue connection and blue bristles	4072400606			
			•												•	RED-RED	FDA approved material-red connection and red bristles	4072400607	
			•													•	GREEN-GREEN	FDA approved material-green connection and green bristles	4072400608
			•													•	YELLOW-YELLOW	FDA approved material-yellow connection and yellow bristles	4072400609
		STAINLESS STEEL + FDA NBR + NYLON	•												•	BLUE	With Stainless Steel EXA connector	4072400542	
			•												•	RED		4072400543	
			•												•	GREEN		4072400544	
			•												•	YELLOW		4072400545	
			•												•	WHITE		4072400546	
		50	FDA NBR + NYLON	•												•	BLUE	FDA approved material	4072400279
	•														•	RED	4072400280		
	•														•	GREEN	4072400281		
	•														•	YELLOW	4072400282		
	•														•	WHITE	4072400283		
STAINLESS STEEL + FDA NBR + NYLON	•													•	BLUE	With Stainless Steel EXA connector	4072400547		
	•													•	RED		4072400548		
	•													•	GREEN		4072400549		
	•													•	YELLOW		4072400550		
	•													•	WHITE		4072400551		
		NYLON BRISTLES	•											WHITE	White bristles, suitable for all FDA round brushes	4082300058			









These round brushes, all with a rubber structure (except for one model in wood and aluminium), are always used for removing and cleaning dust. The round brushes with 38mm coupling should be used together with the fitting with 40/38mm reduction (code 4072200390, see chap 3.b), while the brushes with 50mm coupling can be connected directly to the curved fittings shown in chapter 3.a. These two types of round brushes can also easily be connected to quick-fit extensions with harmonic spring (see chapter 4.b): via the fitting with 40/38mm reduction (code 4072200389) and via the 50mm coupling (code 4072200388), for round brushes with 38mm and 50mm couplings, respectively.

6.a Rubber tools

COLOURED TRIANGULAR BRUSHES	Ø mm	MATERIAL	FEATURES		SECTORS							COLOR	NOTES	CODE
			AUTOCLAVABLE	CERTIFIED THIRD PARTY APPROVAL										
	40	FDA NBR + NYLON	•			•	•			•		BLUE	FDA approved material	4072400284
			•			•	•			•		RED		4072400285
			•			•	•			•		GREEN		4072400286
			•			•	•			•		YELLOW		4072400287
			•			•	•			•		WHITE		4072400288
			•			•	•			•		RED-RED		FDA approved material-red connection and red bristles
	40	STAINLESS STEEL + FDA NBR + NYLON		•		•	•			•	• for EXA machines	BLUE	With Stainless Steel EXA connector	4072400552
				•		•	•			•		RED		4072400553
				•		•	•			•		GREEN		4072400554
				•		•	•			•		YELLOW		4072400555
				•		•	•			•		WHITE		4072400556
	50	FDA NBR + NYLON	•			•	•			•		BLUE	FDA approved material	4072400289
			•			•	•			•		RED		4072400290
			•			•	•			•		GREEN		4072400291
			•			•	•			•		YELLOW		4072400292
			•			•	•			•		WHITE		4072400293
	50	STAINLESS STEEL + FDA NBR + NYLON		•		•	•			•	• for EXA machines	BLUE	With Stainless Steel EXA connector	4072400557
				•		•	•			•		RED		4072400558
				•		•	•			•		GREEN		4072400559
				•		•	•			•		YELLOW		4072400560
				•		•	•			•		WHITE		4072400561
	NYLON BRISTLES	•			•	•			•		WHITE	White bristles, suitable for all FDA round brushes	4082300059	

FDA triangular brushes are suitable for the Food sector to apply the colour coded program. These final tools can be connected both to junction fittings and curved fittings.

6.a Rubber tools

COLOURED RECTANGULAR BRUSHES	Ø mm	MATERIAL	FEATURES		SECTORS							COLOR	NOTES	CODE		
			AUTOCLAVABLE	CERTIFIED THIRD PARTY APPROVAL												
	40	FDA NBR + NYLON	•			•	•						•	BLUE	FDA approved material	4072400294
			•			•	•						•	RED		4072400295
			•			•	•						•	GREEN		4072400296
			•			•	•						•	YELLOW		4072400297
			•			•	•						•	WHITE		4072400298
	40	STAINLESS STEEL + FDA NBR + NYLON	•			•	•						•	BLUE	With Stainless Steel EXA connector	4072400562
			•			•	•						•	RED		4072400563
			•			•	•					•	GREEN	4072400564		
			•			•	•						•	YELLOW		4072400565
			•			•	•						•	WHITE		4072400566
	50	FDA NBR + NYLON	•			•	•						•	BLUE	FDA approved material	4072400299
			•			•	•					•	RED	4072400300		
			•			•	•					•	GREEN	4072400301		
			•			•	•					•	YELLOW	4072400302		
			•			•	•					•	WHITE	4072400303		
	50	STAINLESS STEEL + FDA NBR + NYLON	•			•	•						•	BLUE	With Stainless Steel EXA connector	4072400567
			•			•	•					•	RED	4072400568		
			•			•	•					•	GREEN	4072400569		
			•			•	•					•	YELLOW	4072400570		
			•			•	•					•	WHITE	4072400571		
		NYLON BRISTLES	•			•	•					•	WHITE	White bristles, suitable for all FDA round brushes	4082300060	

FDA rectangular brushes are suitable for the Food sector to apply the colour coded program. These final tools can be connected both to junction fittings and curved fittings.

6.b Examples: **final tools**

E

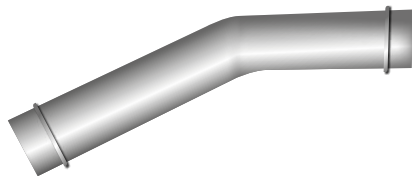

Ø 50 mm
Curved fitting
Z7 21034

I



Ø 50 mm
Cone
Z7 21010

K



Ø 50 mm
Rubber nozzle
Z7 21080

C

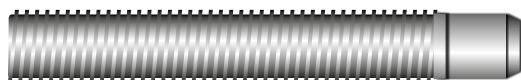

Ø 40 mm
3-meter Air Hose with sleeves
Z7 22049

I

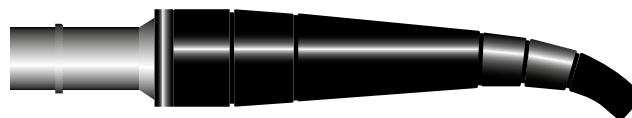

Ø 40 mm
Conical tool
Z7 22142

6.b Examples: final tools

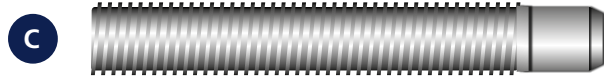

Ø 50 mm
3-meter Polyurethane Hose with sleeves
Z7 22298

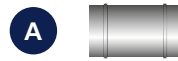

Ø 50 mm
Junction Fitting
Z7 21002



Ø 50 mm
Rubber nozzle
4072100124



Ø 40 mm
3-meter conductive Flex Hose with sleeves
Z7 22150



Ø 40 mm
Scraper nozzle
Z7 22033

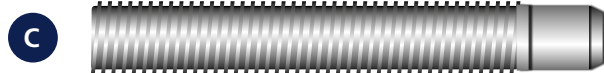

Ø 50 mm
3-meter conductive Flex Hose with sleeves
Z7 22375

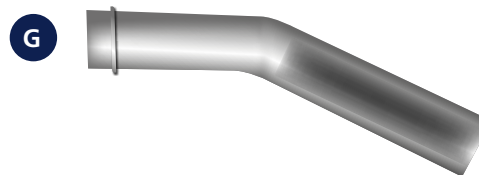

Ø 50 mm
Curved flat-tip crevice nozzle
Z7 21075

6.b Examples: final tools

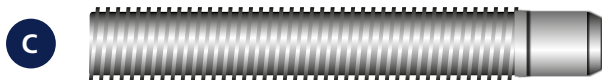

Ø 70 mm
3-meter Polyurethane Hose with sleeves
Z7 22299

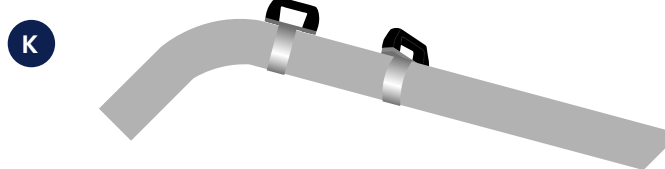

Ø 70 mm
Round crevice nozzle with handles
Z7 22169

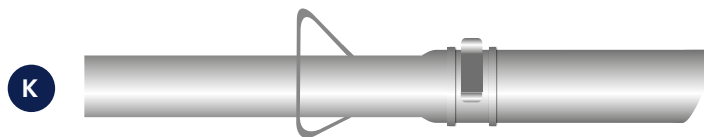

Ø 70 mm
Fluidifying vulk nozzle with regulator
ZA7210026



Ø 40 mm
Quick-fit extensions with harmonic spring
Z7 22386



Ø 40/38 mm
Extension fitting
with reduction
4072200389

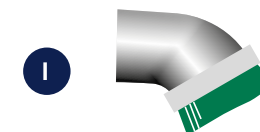

Ø 38 mm
Round brush
10950202

6.b Examples: final tools



Ø 40 mm
Quick-fit extensions with harmonic spring
Z7 22386



Ø 40 mm
Round brush
Z7 22045

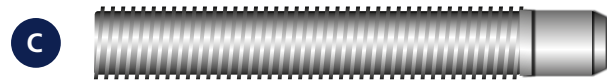

Ø 50 mm
Air Hose by meter
Z7 22062



Ø 50 mm
Round brush
Z7 22047

6.b Examples: final tools

F

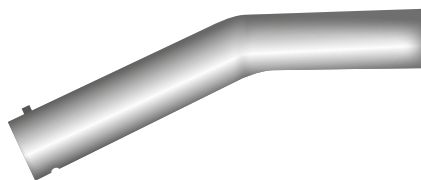

Ø 40 mm
EXA bent fitting
4072100160

K



Ø 40 mm
Silicone cone D40 blue ATEX complete
4072400508

J

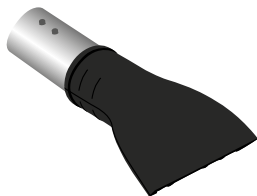

Ø 50 mm
Conductive nozzle D50 120mm ATEX complete - suction point 120 mm
4072400519

K



Ø 32 mm
Conductive nozzle D32 240mm length ATEX complete + Stainless Steel reduction D40/32
4072400599

J

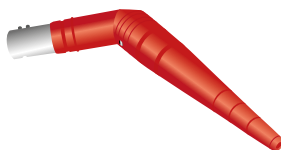

Ø 40 mm
Silicone conical tool FDA red D40/20 ATEX complete
4072400544

6.b Examples: final tools

F

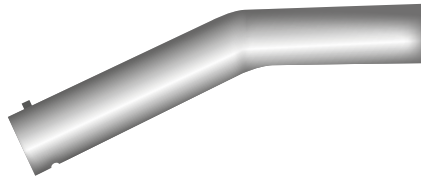

Ø 40 mm
EXA bent fitting
4072100160

I



Ø 40 mm
Round brush FDA green D40 ATEX complete
4072400544

E



Ø 40 mm
EXA extension
4072400658

I



Ø 40 mm
Round brush FDA blue D40 ATEX complete
4072400542

B



Ø 40 mm
3-meter Flex Conductive Hose
4072400451

I

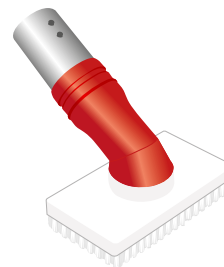



















Ø 40 mm
Rectangular brush D40 ATEX complete red
4072400542









Accessories Kit









A wide range of kits is available: from sets of accessories for general cleaning, to kits for special applications (ex. cleanrooms), to groups of accessories for typical industrial applications and series of accessories for cleaning machinery in general.



















GENERAL CLEANING KIT	Ø mm	LENGTH meters	COMPOSITION	FEATURES							SECTORS							CODE				
				OILPROOF	CONDUCTIVE (*)	ANTISTATIC (**)	HIGH TEMPERATURE	AUTOCLAVABLE	CERTIFIED THIRD PARTY APPROVAL													
	40	3	<ul style="list-style-type: none"> · Zinc-plated reduction Ø 50/40 · 3m Flex hose with sleeves · Chromed handgrip · Wheeled floor nozzle for dust and liquids (width 400mm) · Rubber cone · Round brush with Nylon bristles (80mm) · Zinc-plated flat-tip crevice nozzle (length 500mm) · Zinc-plated junction fitting 																	•	Z7 24145	
	50	3	<ul style="list-style-type: none"> · Zinc-plated reduction Ø 70/50 · 3m Flex hose with sleeves · Chromed handgrip · Wheeled floor nozzle for dust and liquids (width 500mm) · Rubber cone · Round brush with Nylon bristles (100mm) · Zinc-plated flat-tip crevice nozzle (length 500mm) · Zinc-plated junction fitting 																	•	Z7 24146	
<p>The accessories kit for general cleaning is a set of components suitable for light applications. Thanks to the numerous elements (handgrip, wheeled floor nozzle, cone, flat-tip crevice nozzle, etc.) it is extremely versatile. It is available in two sizes: 40mm and 50mm diameter.</p>																						









INDUSTRIAL CLEANING KIT	Ø mm	LENGTH meters	COMPOSITION	FEATURES						SECTORS							CODE
				OILPROOF	CONDUCTIVE	ANTISTATIC	HIGH TEMPERATURE	AUTOCLAVABLE	CERTIFIED THIRD PARTY APPROVAL								
	40	3	<ul style="list-style-type: none"> Zinc-plated reduction Ø 50/40 3m Polyurethane hose with sleeves Chromed handgrip Wheeled floor nozzle for dust and liquids (width 400mm) Rubber cone Round brush with Nylon bristles (80mm) Zinc-plated flat-tip crevice nozzle (length 500mm) Zinc-plated junction fitting 			•					•		•	•	•		Z7 24150
	50	3	<ul style="list-style-type: none"> Zinc-plated reduction Ø 70/50 3m Polyurethane hose with sleeves Chromed handgrip Wheeled floor nozzle for dust and liquids (width 500mm) Rubber cone Round brush with Nylon bristles (100mm) Zinc-plated flat-tip crevice nozzle (length 500mm) Zinc-plated junction fitting 			•					•		•	•	•		Z7 24151
	70	5	<ul style="list-style-type: none"> Zinc-plated reduction Ø 100/70 5m Polyurethane hose with sleeves Chromed handgrip Wheeled floor nozzle for dust and liquids D70 (width 500mm) Zinc-plated junction fitting Rubber cone 			•						•		•	•		4072400247
<p>The industrial cleaning accessories kit is ideal for cleaning spacious areas. Consisting of a 3 meter polyurethane hose, and a complete set of single accessories, this kit lets you clean areas quickly and effectively. The kit in D70 includes the hose in 5m length. The hose must be connected properly if needed.</p>																	







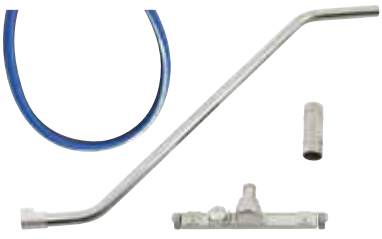

CLEANING MACHINERY KIT	Ø mm	LENGTH meters	COMPOSITION	FEATURES						SECTORS						CODE	
				OILPROOF	CONDUCTIVE	ANTISTATIC	HIGH TEMPERATURE	AUTOCLAVABLE	CERTIFIED THIRD PARTY APPROVAL								
	40	3	<ul style="list-style-type: none"> Zinc-plated reduction Ø 50/40 3m Polyurethane hose with sleeves Zinc-plated junction fitting Conical tool Rubber cone 			•					•		•	•	•		Z7 24155
	50	3	<ul style="list-style-type: none"> Zinc-plated reduction Ø 70/50 3m Polyurethane hose with sleeves Zinc-plated junction fitting Conical tool Rubber cone Rubber sucker 			•					•		•	•	•		Z7 24156
	70	5	<ul style="list-style-type: none"> Zinc-plated reduction Ø 100/70 5m Polyurethane hose with sleeves Zinc-plated junction fitting Conical tool Zinc-plated flat lance 			•					•		•	•	•		4072400248
<p>The kit for cleaning machinery is a set of accessories specifically designed for cleaning dust and residues in general from machinery used during the phases of production and/or other processes. Thanks to the specific components, such as the rubber cone, cleaning is particularly effective. Also in this case there are three available sizes: 40mm, 50mm e 70mm diameter. The hose must be connected properly if needed.</p>																	











FLOORS AND MACHINERY OILPROOF KIT	Ø mm	LENGTH meters	COMPOSITION	FEATURES						SECTORS						CODE	
				OILPROOF	CONDUCTIVE	ANTISTATIC	HIGH TEMPERATURE	AUTOCLAVABLE	CERTIFIED THIRD PARTY APPROVAL								
	40	3	<ul style="list-style-type: none"> Zinc-plated reduction Ø 50/40 3m rubber hose with sleeves Zinc-plated junction fitting Rubber cone Chromed handgrip Wheeled floor nozzle for dust and liquids (width 400mm) 	•	•						•		•	•	•		4072400194
	50	3	<ul style="list-style-type: none"> Zinc-plated reduction Ø 70/50 3m rubber hose with sleeves Zinc-plated junction fitting Rubber cone Chromed handgrip Wheeled floor nozzle for dust and liquids (width 500mm) 	•	•						•		•	•	•		4072400195
	70	5	<ul style="list-style-type: none"> Zinc-plated reduction Ø 100/70 5m rubber hose with sleeves Zinc-plated junction fitting Rubber cone Chromed handgrip Wheeled floor nozzle for dust and liquids (width 500mm) 	•	•						•		•	•	•		4072400249
<p>The oilproof accessories KITS, for both floors and machinery, are suitable for treating all surfaces where oils have to be sucked up. Consisting of oil-resistant rubber accessories, these kits are available in two sizes: 40mm, 50mm and 70mm diameter.</p>																	











PHARMA ACCESSORIES KIT	Ø mm	LENGTH meters	COMPOSITION	FEATURES						SECTORS							CODE	
				OILPROOF	CONDUCTIVE	ANTISTATIC	HIGH TEMPERATURE	AUTOCLAVABLE	CERTIFIED THIRD PARTY APPROVAL									
	40	3	<ul style="list-style-type: none"> · AISI 316L reduction Ø 50/40 · 3m antistatic hose with sleeves · AISI 316L bent connection · AISI 316L flat lance · AISI 316L handgrip · Mobile nozzle + silicone · Silicone cone 			•				•		•						4072200612
	50	3	<ul style="list-style-type: none"> · AISI 316L connection tube Ø 50 · 3m antistatic hose with sleeves · AISI 316L bent connection · AISI 316L flat lance · AISI 316L handgrip · Mobile nozzle + silicone · Silicone cone 			•				•		•						4072200613
	40	3	<ul style="list-style-type: none"> · AISI 316L reduction Ø 50/40 · 3m silicone hose with sleeves · AISI 316L bent connection · AISI 316L flat lance · AISI 316L handgrip · Mobile nozzle + silicone · Silicone cone 							•		•						4072200614
	50	3	<ul style="list-style-type: none"> · AISI 316L connection tube Ø 50 · 3m silicone hose with sleeves · AISI 316L bent connection · AISI 316L flat lance · AISI 316L handgrip · Mobile nozzle + silicone · Silicone cone 							•		•						4072200615
<p>Two different kits have been developed according to the main needs in the pharmaceutical production companies. The difference is the type of hose: the standard kit includes the antistatic transparent hose, while the premium kit includes the new silicone hose.</p>																		

IVT1000 KIT	Ø mm	LENGTH meters	COMPOSITION	FEATURES						SECTORS						CODE				
				OILPROOF	CONDUCTIVE	ANTISTATIC	HIGH TEMPERATURE	AUTOCLAVABLE	CERTIFIED THIRD PARTY APPROVAL											
	32	3	<ul style="list-style-type: none"> · 3m plastic hose with sleeves · Stainless steel extension/handgrip (2 pieces) · Standard nozzle (width 300mm) · Stainless steel connecting tube (length 250mm) · Rubber cone · Stainless steel flat-tip crevice nozzle (length 250mm) · Metal hose clamp (2 pieces) 															80551100		
			<ul style="list-style-type: none"> · 3m antistatic plastic hose with sleeves · Stainless steel extension/handgrip (2 pieces) · Antistatic nozzle (width 300mm) · Stainless steel connecting tube (length 250mm) · Conductive conical tool · Stainless steel flat-tip crevice nozzle (length 250mm) · Metal hose clamp (2 pieces) 																	80551200
			<ul style="list-style-type: none"> · 3m silicone hose with sleeves · Stainless steel extension/handgrip (2 pieces) · Nozzle for autoclaves (width 300mm) · Stainless steel connecting tube (length 250mm) · Silicone cone · Stainless steel flat-tip crevice nozzle (length 250mm) · Metal hose clamp (2 pieces) 																	
<p>These three accessories kits are only for the IVT1000 vacuum cleaner. All three are only available with a 32mm diameter. While the standard set is indicated for light applications, the antistatic kit is ideal where antistatic applications are required; the autoclave kit is an optimal solution for all applications where the accessories have to be sterilized. The metal accessories are made of AISI316 stainless steel.</p>																				









ALIMENTARY KIT FLOOR	Ø mm	LENGTH meters	COMPOSITION	FEATURES						SECTORS							CODE	
				OILPROOF	CONDUCTIVE	ANTISTATIC	HIGH TEMPERATURE	AUTOCLAVABLE	CERTIFIED THIRD PARTY APPROVAL									
	40	3	<ul style="list-style-type: none"> Stainless steel reduction Ø 50/40 3m rubber hose for food Stainless steel handgrip Stainless steel wheeled floor nozzle for dust and liquids (width 400mm) 	•							•	•						4072400210
	50	3	<ul style="list-style-type: none"> Stainless steel hose fitting Ø 50 3m rubber hose for food Stainless steel handgrip Stainless steel wheeled floor nozzle for dust and liquids (width 400mm) 	•							•	•						4072400209
	40	3	<ul style="list-style-type: none"> Stainless steel reduction Ø 50/40 3m rubber hose for food Stainless steel junction fitting Flat lance Silicone cone 	•							•	•						4072400206
	50	3	<ul style="list-style-type: none"> Stainless steel reduction Ø 50/40 3m rubber hose for food Stainless steel junction fitting Flat lance Silicone cone Silicone nozzle 	•							•	•						4072400205
The alimentary kit includes an FDA hose and there are two versions for floor cleaning and machinery cleaning.																		

OVENS KIT	Ø mm	LENGTH meters	COMPOSITION	FEATURES						SECTORS						CODE	
				OILPROOF	CONDUCTIVE	ANTISTATIC	HIGH TEMPERATURE	AUTOCLAVABLE	CERTIFIED THIRD PARTY APPROVAL								
	40	3	<ul style="list-style-type: none"> 3m flexible steel hose with zinc-plated reduction and fitting Al 1m extension (3 pieces) with quick-fit coupling Wheeled nozzle for cleaning ovens Sliding PTFE sleeve 				•					•		•			Z7 24193
	50	3	<ul style="list-style-type: none"> 3m flexible steel hose with zinc-plated reduction and fitting Al 1m extension (3 pieces) with quick-fit coupling Wheeled nozzle for cleaning ovens Sliding PTFE sleeve 				•					•		•			Z7 24192
	40	3	<ul style="list-style-type: none"> High temperature flexible hose (3 meters + metal ties) with zinc-plated reduction and fitting Aluminum 1 m extension (3 pieces) with quick-fit coupling Wheeled nozzle for oven cleaning Sliding PTFE sleeve 				•					•		•			4072200616
	50	3	<ul style="list-style-type: none"> 3 m steel hose with zinc-plated reduction and fitting Aluminum 1 m extension (3 pieces) with quick-fit coupling Wheeled nozzle for cleaning ovens Sliding PTFE sleeve 				•					•		•			4072200617
<p>The oven cleaning kit is a specific set of accessories designed for cleaning inside ovens. Consisting of a 3 meter steel hose, with sleeve (silicone) and all the fittings and reductions necessary, three 1m extensions with a sliding PTFE sleeve and a wheeled nozzle with two silicone lips, this set is very practical and effective, also thanks to the connecting system (with harmonic spring) and the reduced weight. There are two sizes available: 40mm and 50mm diameter.</p> <p>The kit with the flexible hose includes the hose made up with glass fiber and silicone reinforced tissue with galvanized steel spiral and its metal ties.</p>																	











ATEX KIT	Ø mm	LENGTH meters	COMPOSITION	FEATURES						SECTORS							CODE		
				OILPROOF	CONDUCTIVE	ANTISTATIC	HIGH TEMPERATURE	AUTOCLAVABLE	CERTIFIED THIRD PARTY APPROVAL										
	40	3	<ul style="list-style-type: none"> 3m Flex conductive Hose Conductive sleeve (2 pieces D38) Stainless steel handgrip Stainless steel wheeled floor nozzle for dust and liquids (width 400mm) Stainless steel curved fitting Conductive cone Stainless steel flat-tip crevice nozzle 		•						•		•	•	•	•	•	•	Z7 24185
	38/40	3	<ul style="list-style-type: none"> 3m Flex conductive Hose Conductive sleeve (2 pieces D38/40) Stainless steel handgrip Stainless steel wheeled floor nozzle for dust and liquids (width 400mm) Stainless steel curved fitting Conductive cone Stainless steel flat-tip crevice nozzle 		•						•		•	•	•	•	•	•	4072400246
	50	3	<ul style="list-style-type: none"> 3m Flex conductive Hose Conductive sleeve (2 pieces) Stainless steel handgrip Stainless steel wheeled floor nozzle for dust and liquids (width 400mm) Stainless steel curved fitting Conductive cone Stainless steel flat-tip crevice nozzle 		•						•		•	•	•	•	•	•	Z7 24182
	40	3	<ul style="list-style-type: none"> 3m Flex conductive Hose Conductive sleeve (2 pieces D38) Stainless steel handgrip Stainless steel wheeled floor nozzle for dust and liquids (width 400mm) 		•						•		•	•	•	•	•	•	Z7 24186
	50	3	<ul style="list-style-type: none"> 3m Flex conductive Hose Conductive sleeve (2 pieces) Stainless steel handgrip Stainless steel wheeled floor nozzle for dust and liquids (width 400mm) 		•						•		•	•	•	•	•	•	Z7 24183

ATEX KIT	Ø mm	LENGTH meters	COMPOSITION	FEATURES						SECTORS							CODE	
				OILPROOF	CONDUCTIVE	ANTISTATIC	HIGH TEMPERATURE	AUTOCLAVABLE	CERTIFIED THIRD PARTY APPROVAL									
	40	3	<ul style="list-style-type: none"> 3m Flex conductive Hose Conductive sleeve (2 pieces D38) Stainless steel curved fitting Conductive cone Stainless steel flat-tip crevice nozzle 		•						•		•	•	•	•	•	Z7 24187
	50	3	<ul style="list-style-type: none"> 3m Flex conductive Hose Conductive sleeve (2 pieces) Stainless steel curved fitting Conductive cone Stainless steel flat-tip crevice nozzle 		•						•		•	•	•	•	•	Z7 24184
	40	3	<ul style="list-style-type: none"> 3m Flex conductive Hose Conductive sleeve (2 pieces D38) Conductive cone Stainless steel flat-tip crevice nozzle 		•						•		•	•	•	•	•	Z7 24175

The ATEX accessories kits, including the kit for the 15ATEX vacuum cleaner, are an optimal solution when conductivity is obligatory. Available in three versions, from the complete version for cleaning both floors and machinery, to the version for cleaning machinery, or the set for cleaning floors, these accessories kits consist of conductive or antistatic elements. Each kit is available in two different sizes: 40mm and 50mm diameter.

ANTISHOCK KIT	Ø mm	LENGTH meters	COMPOSITION	FEATURES						SECTORS							CODE		
				OILPROOF	CONDUCTIVE	ANTISTATIC	HIGH TEMPERATURE	AUTOCLAVABLE	CERTIFIED THIRD PARTY APPROVAL										
	40	5	<ul style="list-style-type: none"> chromed reduction (the reduction 50/40 for the kit D40, and the reduction 70/50 for the kit D50) 5 m flex conductive hose 2 conductive sleeves Chromed handgrip 			•													4072200653
	50		<ul style="list-style-type: none"> Wheeled anti-shock floor nozzle for dust (width 400mm) with silicone lips Zinc plated curved fitting Antistatic round brush Zinc plated flat lance Conductive cone 			•													4072200652

The new anti-shock version has been implemented to be used in the B&C sector in order to dissipate any static charges caused by the passage of dust. It includes a conductive hose, a conductive cone, an antistatic round brush and a specific anti-shok nozzle with silicone lips.

EXA KIT	Ø mm	LENGTH meters	COMPOSITION	FEATURES						SECTORS							CODE
				OILPROOF	CONDUCTIVE	ANTISTATIC	HIGH TEMPERATURE	AUTOCLAVABLE	CERTIFIED THIRD PARTY APPROVAL								
	40	5	ATEX Accessories Kit (complete) · Conductive Hose 5m, · Handgrip, · Curved Connection, · Mobile Sucker, · Conductive Cone, · Flat Lance, · Antistatic Round Brush		•					•	•		•	•	•	• for EXA machines	4072200662
	50				•					•	•		•	•	•		4072200663
	40	5	ATEX Antistatic Accessories Kit (complete) · Antistatic Hose 5m, · Handgrip, · Curved Connection, · Mobile Sucker, · Conductive Cone, · Flat Lance, · Antistatic Round Brush			•				•	•		•	•	•	• for EXA machines	4072200666
	50					•				•	•		•	•	•		4072200667
	40	5	Antistatic Accessories Kit for floor cleaning · Antistatic Hose 5m, · Handgrip, · Mobile Sucker			•				•	•		•	•	•	• for EXA machines	4072200668
	50				•				•	•		•	•	•	4072200669		
	40	5	Antistatic Accessories Kit for machines cleaning · Antistatic Hose 5m, · Curved Connection, · Conductive Cone, · Flat Lance, · Antistatic Round Brush			•				•	•		•	•	•	• for EXA machines	4072200670
	50				•				•	•		•	•	•	4072200671		

The EXA accessories kit includes certified accessories suitable for EXA machines. It is available in 2 versions for cleaning both floors and machinery. All items include the PIN connection.

OVERHEAD CLEANING KIT	Ø mm	COMPOSITION	FEATURES						SECTORS							CODE
			OILPROOF	CONDUCTIVE	ANTISTATIC	HIGH TEMPERATURE	AUTOCLAVABLE	CERTIFIED THIRD PARTY APPROVAL								
	40	<ul style="list-style-type: none"> · Adapter for the hose · 4 Carbon fiber poles (6 meters) · 2 Round brushes of different diameters · Conductive flat lance · 2 Curved connectors 		•					•	•	•	•	•	•	•	4072400651
	<p>The new carbon fiber kit is suitable for overhead cleaning. It does not include the hose, so it can be connected to standard hoses with sleeves. It can be used with EXA machines thanks to the connection hoses. (see chapter 2.a Hoses- connection EXA hoses).</p>															

CONVERSION KIT	Ø mm	COMPOSITION	FEATURES						SECTORS							CODE
			OILPROOF	CONDUCTIVE	ANTISTATIC	HIGH TEMPERATURE	AUTOCLAVABLE	CERTIFIED THIRD PARTY APPROVAL								
	50	Conversion kit for grey line machines							•			•	•	•	• for EXA machines	4089100928
	70								•			•	•	•		4089100929
	100									•			•	•		•
	50	Conversion kit for VHW series							•			•	•	•		4089100981
	70								•			•	•	•		4089100982
<p>The conversion kit has been developed to allow the usage of EXA certified accessories also on machines already on the field. They are available for both the Grey line and also the White line.</p>																

Notes

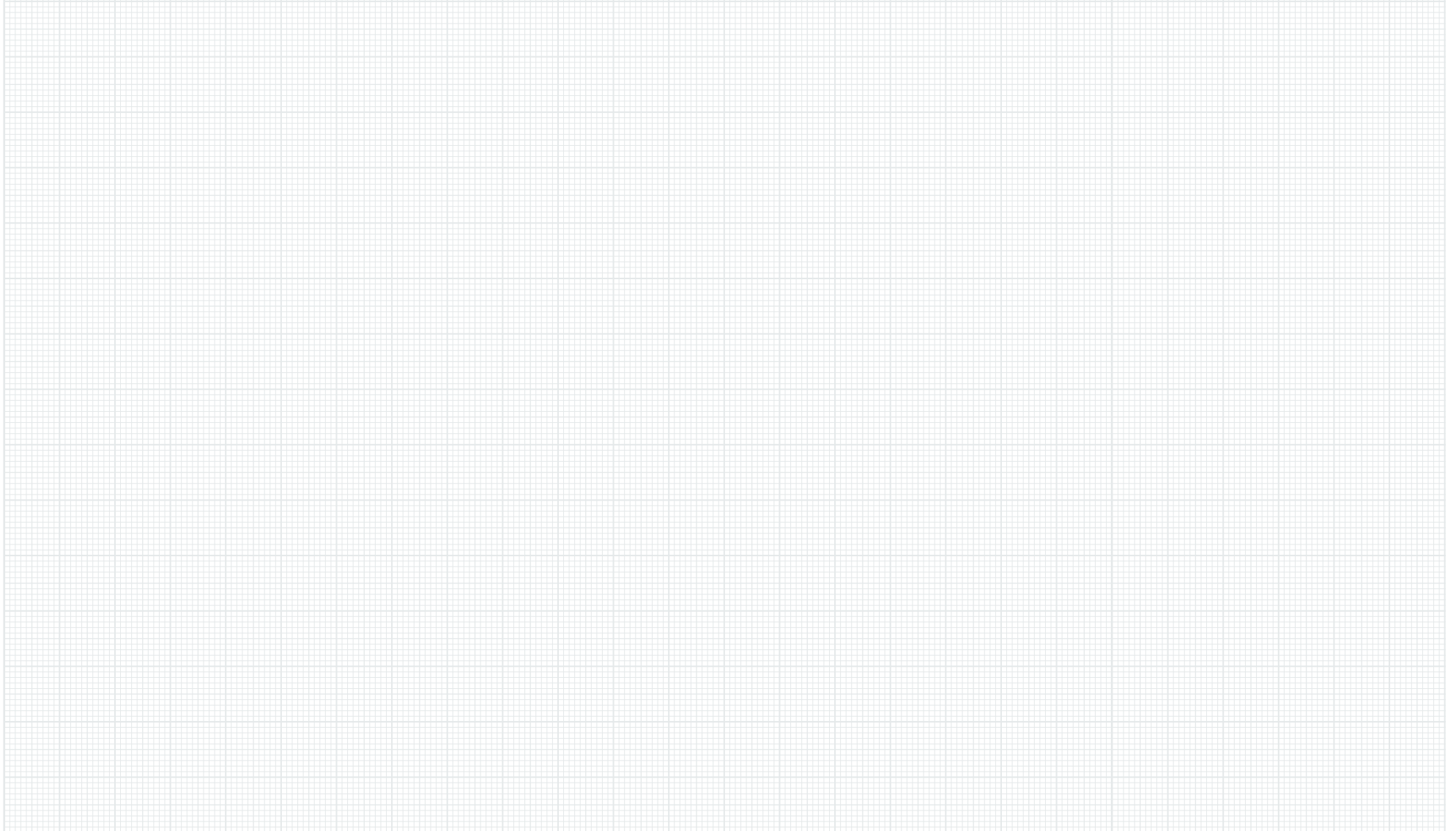

Notes

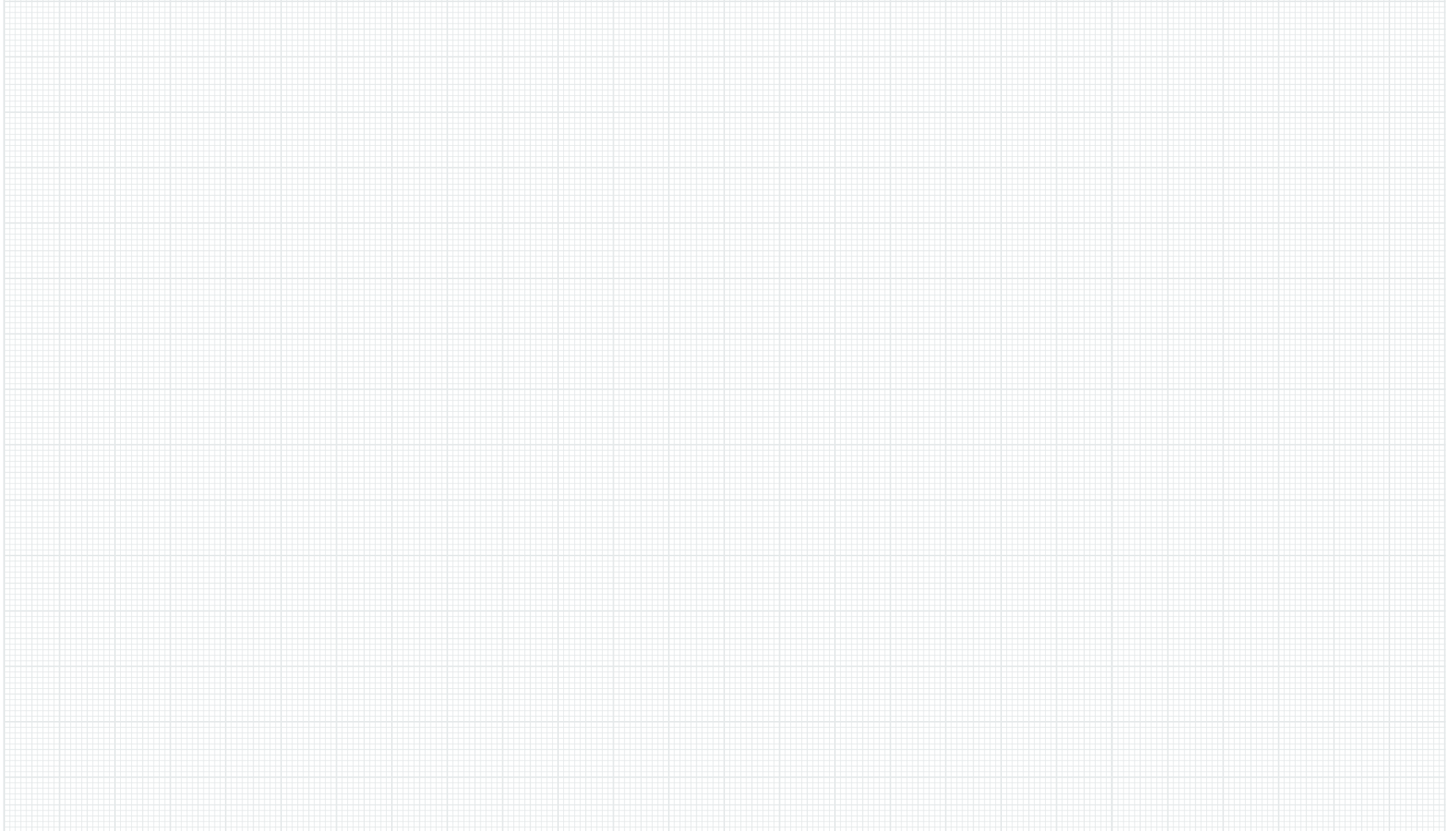

Nilfisk S.p.A. a socio unico

Via Porrettana, 1991 - 41059 Zocca, (Modena) - Italy

Tel. +39 059 9730000 - Fax +39 059 9730065

industrial-vacuum@nilfisk.com

www.nilfisk.com

